

A GUIDE TO SETUP
AND ADJUST THE CRT
OF AN ARCADE COLOR
MONITOR

INGVAR KARLSSON

Contents

Document Revision	3
Possible Future Document Updates	3
Acknowledgements	4
Special Thanks	4
Introduction	5
Scope of the document.....	5
Safety	5
Background	6
Nomenclature.....	6
CRT	7
The Need for Degaussing.....	8
External Degaussing Coil.....	9
<i>Warning</i>	10
Concentric Convergence Assembly.....	10
<i>Purity</i>	11
<i>Static Convergence</i>	12
<i>Concentric Multi-pole Magnets</i>	12
<i>How To Move Electron Beams Individually</i>	12
<i>The Multi-pole Ring Magnets in Detail</i>	14
Deflection Yoke.....	15
<i>Purity</i>	15
<i>Dynamic Convergence</i>	15
<i>Picture Rotation</i>	16
<i>Deflection Yoke in Detail</i>	16
Different Voltages to a PAG.....	18
The B+ Voltage.....	18
Flyback Transformer.....	18
Complete Electron Gun including the CRT screen.....	19
<i>Creating electrons</i>	19
<i>Accelerating Electron and Beam forming</i>	20
<i>Control grid – G1</i>	20
<i>Screen Grid – G2</i>	21
<i>Focus Grid – G3</i>	21
<i>Steering the Beam (Deflection)</i>	21
<i>Anode – G4</i>	21
<i>CRT Screen</i>	21
<i>Summary of the Electron Optics</i>	22
<i>Electrical Connections TO A CRT</i>	23
Geometric Distorsions in a CRT.....	23
Monitor Convergence “the lean way”.....	24
Monitor Convergence Tips.....	24
Horizontal Centering (Purity).....	26
Vector Monitor.....	26
Raster Monitor.....	27
Static Convergence.....	28
4-pole Magnetic Pair.....	28
6-pole Magnetic Pair.....	29
Dynamic Convergence	30
Procedure.....	30
Tracking (White Balance).....	32
Controls.....	32
CRT Transfer Characteristics	32

<i>Contrast</i>	32
<i>Brightness</i>	33
Procedure.....	34
Optimizing Purity In a Raster Monitor.....	36
Procedure.....	36
Warning.....	36
Optimizing Dynamic Convergence	37
Permalloy Strip.....	37
Procedure.....	38
Warning.....	38
Setup Procedure of a WG19K6100 Monitor.....	39
Coarse Procedure Outline.....	39
Initial Setup.....	40
Horizontal Centering (Purity).....	42
Static Convergence	43
Dynamic Convergence	44
Tracking	46
Optimizing convergence	47
Setup Procedure of a 19" Amplifone Monitor	48
Setup Procedure of a 19" WG K4900 MonitoR.....	48

DOCUMENT REVISION

Revision	Note
v1.0	Initial release
v1.0.1	Added table for document revision. Corrected misspelling (PAA => PAG). Added text "RCA 19VLUP22" in picture text in section Initial Setup.
V1.1.0	Added section about the lean way of convergence. Added a section about different voltages to a CRT together with a more in-depth explanation. Added a section about geometry distortions. Removed text justification throughout the document.
V1.2.0	First official release

POSSIBLE FUTURE DOCUMENT UPDATES

- Section about setup of a 19" Amplifone Monitor
- Section about setup of a 19" WG K4900 Monitor as a raster reference

ACKNOWLEDGEMENTS

Different sources have been used to compile this document where most are from existing documents and some from my own experience. Here is a non-conclusive list of information sources that earn the due credits.

Atari: TM-183, Wells-Gardner Quadrascan Color X-Y Display Service Manual, 3rd printing

James Dinndorf: Monitor Convergence Tips, text from <http://www.arcaderepairtips.com/>

RetroHacker: Miscellaneous posts at the KLOV forums

Jed Margolin: The secret Life of XY Monitors

Ray Carlsen: Setup Adjustments for CRT Color Monitors, June 07 2005.

Charles Poynton: "Brightness" and "Contrast" controls

Wells-Gardner: 19K4900 Color Monitor Manual

Wells-Gardner: K7500 Service Manual

Samuel M. Goldwasser: TV and Monitor CRT (Picture Tube) Information, version 1.77.

Samuel M. Goldwasser: Information from www.repairfaq.org

Silicon Chip: Serviceman's Log #195, December 2004

Gregg Woodcock: How to diagnose, repair and upgrade your Amplifone and Wells-Gardner Color Vector (XY) monitors, version 6.1, April 6 1996.

National Semiconductor, AN656: Understanding The Operation of a CRT Monitor, November 1989

Kenneth Compton: Image Performance in CRT displays, 2003

Internet: Various bits and pieces here and there (they are too many to list in detail)

Forum threads at: <http://www.neo-geo.com/forums/>

Unknown: Wells-Gardner 6100 Vector Monitor FAQ and guide, version 1.1, June 13 2002.

Unknown: DX2P Geometry, Convergence, and Purity Adjustments.

SPECIAL THANKS

A special thanks to the staff at Arcade Repair Tips that host this document. I strongly recommend visiting their website (www.arcaderepairtips.com) and discover a goldmine of information about repairing arcade games. If you have any comments, both good and bad, about this document please send them an email and they will forward it to me. Another special thanks is to Chad Entringer for the technical review of this document. Please pay him a visit at his website (www.arcadecup.com) for everything related to professional monitor repair.

INTRODUCTION

SCOPE OF THE DOCUMENT

This guide focuses on the setup and adjustments of a CRT located inside monitors mainly used in arcade games. Arcade games use either a vector or a raster monitor. The setup of the two types is basically the same with only minor differences. This document will be about Vector monitors, although most of the information can be used for raster monitors as well (even for TVs). If something is only applicable to a raster monitor or a vector monitor it will have a separate explicitly section with a heading name including RASTER MONITOR or VECTOR MONITOR.

If there are differences that need to be emphasized between vector monitors and raster monitors it will show up in a blue box like this.

Important information will show up in a red box like this.

As this guide is **only** about **setup and adjustment of a CRT**, it will not in detail explain the rest of the functions in a monitor or how to repair one. If the reader needs more background information regarding monitors in general it needs to be collected from other sources.

For this guide to be fairly accurate it involves the following pre-requisites:

1. The monitor at hand is a Vector monitor
 - a. from Wells-Gardner - 19K6100 series
 - b. or from Amplifone
2. The monitor at hand has a CRT that is designed with the electron guns located side by side (aka in line). These CRT-tubes are called "in-line" and sometimes "aperture grille" or "slot mask".

SAFETY

If you have never adjusted a monitor before, keep in mind there are dangerous voltages inside. The most obvious is the high voltage on the picture tube, but you are not likely to lift the cap on the CRT during your setup adjustments. The not-so-obvious danger is that monitors and TV sets are "line operated" devices. That means that the chassis is "hot" to ground at all times and poses a lethal potential between chassis parts and other grounded objects around it. Technicians often use a 1:1 isolation transformer to reduce the risk of shock and damage to equipment.

You can work in reasonable safety if you keep other grounded objects (computer, drives, etc.) away from your work area. Use only with hand in the monitor (put the other hand in your pocket) to reduce the risk of electrical shock. Taking an electrical shock from arm to arm across the chest can stop your heart.

BACKGROUND

NOMENCLATURE

The actual “Picture Generating Assembly” in a monitor consists of the following three parts:

1. Concentric Convergence Assembly [Magnetic rings to adjust for imperfection in the CRT]
2. Deflection Yoke [Coil arrangement to deflect the electron beam]
3. CRT (Cathode Ray Tube) [This is the picture glass bell. Also called picture tube]



CCA + Deflection Yoke + CRT = Picture Generating Assembly (often called CRT!)

The **Picture Generating Assembly** is often referred to simply the CRT. This is not actually correct as the CRT is technically the “picture glass bell” but nevertheless, CRT is often used for the three parts together described above. So, be aware of the use of the word CRT!



PGA + Electronics + Mechanical Chassis = Monitor

The **PGA** together with electronics and a mechanical chassis will be the actual monitor. A monitor is fed with power and a video signal and produces a picture.

This guide will focus on setup and adjustment of the Picture Generating Assembly only.

CRT

The most common CRT nowadays (introduced by Sony 1968 and was called Trinitron) has three in-line (side by side) electron guns rather than the triad arrangement of the earlier types (these old CRT used a shadow mask which were full of small holes). With in-line tubes, the deflection yoke is designed to match the picture tube so only simple corrections are needed to produce an acceptable picture. Setup adjustments are done by moving several sets of rings on the neck of the tube and the position (tilt and lateral) of the deflection yoke. The rings are made of magnetized material to direct the CRT electron beams to the desired locations on the CRT screen. The three major alignments are "horizontal centering" (or "purity" in raster monitors), "static convergence" and "dynamic convergence". The term "static" simply means electron beam correction with stationary ring magnets rather than with electronic circuitry and/or the position of the deflection yoke. The latter is usually referred to as "dynamic" convergence.

Sony's Trinitron design uses a variation of the shadow mask called the aperture grill (or guard grill). Rows of very fine metal strips run vertically down the CRT screen, separating columns of colored phosphor which are arranged in alternating stripes of red, green and blue.

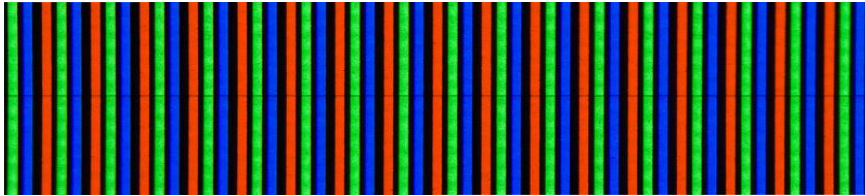

Close-up of a Trinitron CRT screen

This configuration allows the phosphor strips to be placed closer together than conventional dot triads, and the fine vertical wires block less of the electron beam than traditional shadow masks, resulting in a brighter CRT screen, and less thermal build-up and distortion. Coupled with changes in the way that the electron guns are arranged in-line, this design results in a crisp, bright CRT screen. However, the vertical strips are so fine that they can be set into motion when contacted by the electron beam due to thermal changes. This would result in a shimmer on the CRT screen which would be quite distracting. To remedy this, Sony put horizontal stabilizing wires across the vertical ones. This reduces shimmer, but results in one or more fine horizontal lines being visible on the CRT screen. Usually, these lines are only visible to a discerning viewer when looking at a bright, solid background.

A variant of the aperture grille is the slot-mask. In a "slot mask" monitor - the phosphor CRT screen consists of triples of vertically elongated R, G, and B, stripes. Actually, these are usually full vertical stripes interrupted by narrow gaps. The slot-mask is a steel or InVar sheet filled with slots - one for each color triple. Ideally, the metal between the slots vertically is as thin as possible to maintain the structural stability of the slot-mask sheet. The setup and adjustments of a slot-mask CRT is **the same** as with an aperture grill CRT.

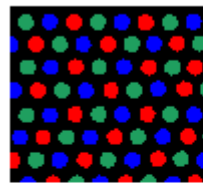

Shadow mask

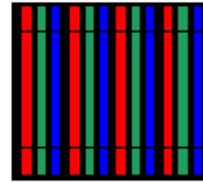

Aperture grille
(slot mask)
Sony Trinitron

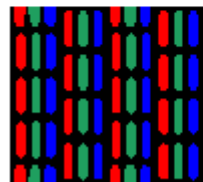

Slot mask
NECT Cromaclear

Don't wash your CRT until you have confirmed that your paint of a graphite pigment is not water soluble. It may all come off! Wipe off the dirt and dust with a cloth. The paint is often called “Dag” (a short for Aquadag – trademark of Acheson Colloids). It is a type of paint made of a graphite pigment which is conductive. It is painted onto the inside and outside of CRT to form the two plates of a high voltage filter capacitor using the glass in between as dielectric. This capacitor is between 0,005uF and 0,01uF in value. This seems like very little capacity but it can store a substantial charge with 25.000 volts applied. The outside “dag” is always connected to the circuit chassis ground via a series of springs, clips, and wires around the CRT.

The high voltage terminal must be discharged to chassis ground before working with the monitor.

THE NEED FOR DEGAUSSING

When a CRT is subjected to a magnetic field that is **different** than when it was latest adjusted, it will result in color distortion. Examples of changes in an ambient magnetic field that can affect the CRT are:

- the earth's magnetic field
- the electronics/electrics of the monitor itself
- all electronic/electrical equipment in close proximity
- a lighting strike nearby
- permanent magnets (such as speakers) in close proximity

The main reason for color distortion is that the aperture grille (and the magnetic shield hood if present) is magnetized differently than when the CRT was adjusted the last time. So, basically color distortion will happen as soon as you **move** the CRT for the **first time** due to the changes in the earth's magnetic field or when something that creates a magnetic field is located close to the monitor. This gets even stranger when we find out that the aperture grille is made of a magnetic material! How is this handled?

The aperture grille together with the internal magnetic shielding hood in the monitor forms sort of a closed space in which it is attempted to achieve a magnetic field-free space for the CRT. The purpose of degaussing is *not* to demagnetize the metal, but to create a magnetization that compensates for the earth's magnetic field. The **sum** of the two magnetic fields must be near

zero! Degaussing coils create a strong alternating magnetic field that gradually decays to zero. The effect is that the present earth magnetic field is "frozen" into the magnetic shielding (and the aperture grille) and the magnetic field inside the shielding will be (almost) zero. Non-zero magnetic field will cause color distortion. This explains why a CRT must be degaussed again, after it has been moved relative to the earth's magnetic field. The axial component of the earth's magnetic field is harder to compensate by means of degaussing. CRT's for moving vehicles (like military airplanes) may be equipped with 6 coils to achieve zero magnetic field in all directions. They use magnetic field sensors and active compensation, thus they don't need any degaussing function. But this is too expensive for consumer equipment.

The monitor has a built-in degaussing function that will de-magnetize (actually magnetize) the aperture grille (and magnetic shield hood if present) every time the monitor is turned on. But this function is not always enough in the long run and we need to externally degauss the CRT sometimes. This is especially important when we setup and adjust a CRT.

CRT manufacturers actually make different versions of their CRT's in monitors/TV - for the northern and southern hemisphere, and sometimes a 3rd neutral type. These are so-to-speak pre-corrected for the uncompensated magnetic field. They do this by adjusting for optimum color purity in a simulated magnetic field. This is one reason why the high voltage terminal of a CRT always should be **on top!** There are stories about technicians that used upside-down CRT's from the "wrong" hemisphere to make it work.

EXTERNAL DEGAUSSING COIL

A hand-held degaussing coil consists of a hundred or so turns of magnet wire in a 15-30 cm diameter coil. They include a line cord and momentary switch. You flip on the switch (at a distant from the CRT), and then bring the coil flat to the CRT screen. Not too close though. **Be aware as too strong magnetic field can deform the aperture grille permanent!** Then slowly make small circular motion with the coil. Make the circular motion bigger and bigger and at the same time slowly decrease the magnetic field by backing straight away across the room as you hold the coil. When you are farther than 3 meters away and you cannot see any effect of the coil - turn the coil so it is at right angles to the CRT screen (which minimizes the magnetic field the monitor is seeing), and THEN turn the coil off. This is to reduce the possibility of any magnetic field transient caused by switching the coil off from leaving you once again with a wrong magnetized monitor. The key word here is slow. Go too fast and you will freeze the instantaneous intensity of the 50/60 Hz AC magnetic field variation into the ferrous components of the CRT and may make the problem worse.

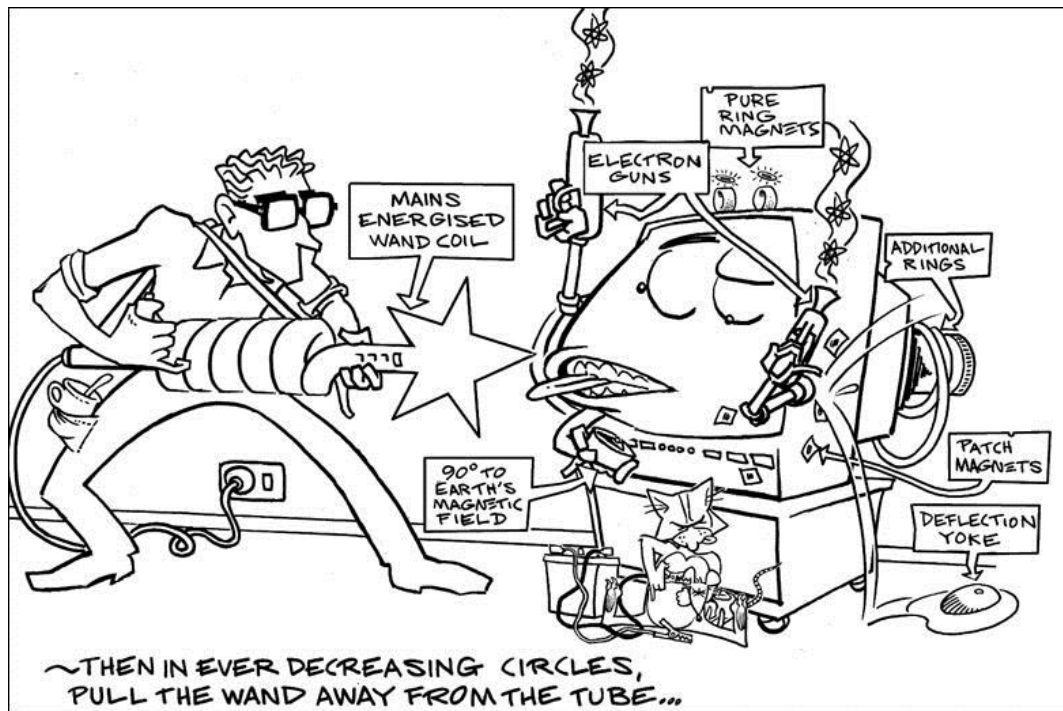

WARNING

An excessively strong magnetic field, whether alternating or constant, may mechanically deform (bend) the aperture grille, causing a permanent color distortion on the display which looks very similar to a magnetization effect. So be careful not to use an over-powered external degaussing coil to close to the CRT screen!

CONCENTRIC CONVERGENCE ASSEMBLY

The **Concentric Convergence Assembly** is located around the cylindrical part of the CRT neck and is used to compensate for the different imperfections and manufacturing variations in the CRT (the deflection yoke position is actually also a part of this compensation – see section *Deflection Yoke*). The compensating is done by adjusting concentric rings with a multi-pole magnet arrangement. The CCA also needs to be in the correct position on the CRT neck. The service manual for the monitor usually gives the position on the CRT neck where the purity multi-pole ring magnets of the CCA should be placed.

In-line CRTs use a large common cathode to emit electrons, via individually controlled electron gates creating three electron guns that emit an electron beam each which focus through electrostatic lenses. See section *Different Voltages to a* for more explanation of creating electron beams and the voltages needed. These three electron beams will create red, green and blue color on the CRT screen. But the three electron beams are usually called just R-beam, G-beam and B-beam.

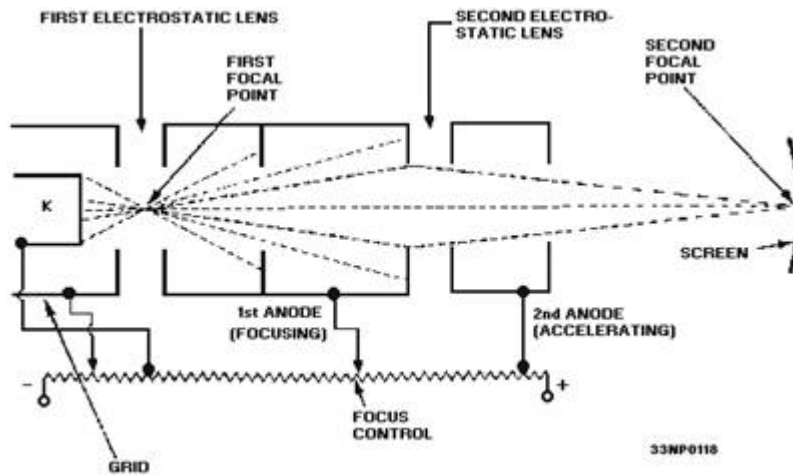

Creating electron beams with focusing through electrostatic lenses

Since the electron beams for the R, G, and B phosphors originate from slightly different positions (individual electron guns) and thus arrive at slightly different angles, only the proper phosphors are excited when the color purity is properly adjusted and the necessary magnetic field free region is maintained inside the CRT.

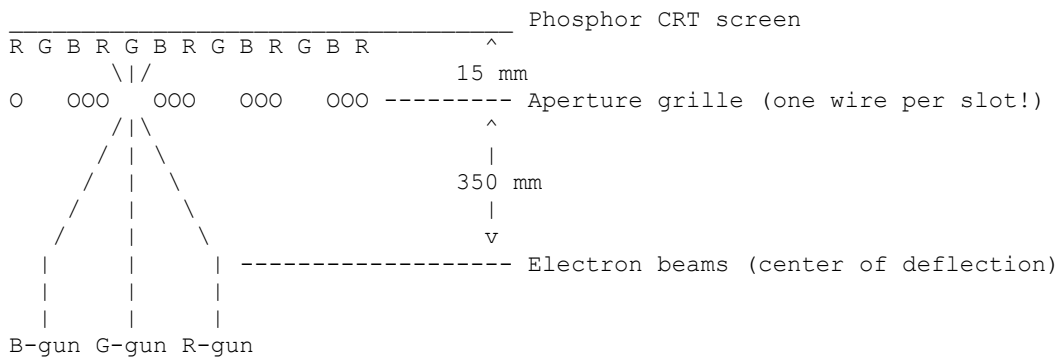

Three electron beams hit the correct spot on CRT screen through an aperture grille

There are two different adjustments made in the **Concentric Convergence Assembly** – purity and static convergence.

PURITY

Purity assures that each of the electron beams for the three primary colors - red, green, and blue – crosses the space between the metal strips at the proper angle and will only strike the proper phosphor for that color. Purity is said to be good if, when each color is turned on and the other two turned off, the entire CRT screen is all one color. Bad purity will show up as wrong colors on what should be a pure color field, or color blotches on what should be a white CRT screen (all three guns turned on). Objects will change shades of color when moved from one part of the CRT screen to another.

This adjustment is called horizontal centering in a vector monitor and purity in a raster monitor. The adjustments are done the same but with slightly different test video signals (Raster monitors use a pure color signal – often a red raster. Vector monitors use a crosshatch test pattern with one color – often green). Even in the documentation for vector monitors it is often faultily called purity – even sometimes in this document. But you will have to live with that ☺.

STATIC CONVERGENCE

Static Convergence determines the geometric alignment of the three primary colors in the **center** of the CRT screen. A CRT is said to be in convergence when all three electron beams (primary colors of R, G and B) overlap in all places on the CRT screen (so white appears as white and nothing else). Misconvergence shows up as color "fringing" around the edges of objects anywhere on the CRT screen.

CONCENTRIC MULTI-POLE MAGNETS

As the three electron guns are arranged in-line with the **green gun always in the middle**. Some of the magnetic ring adjustments are designed to affect all electron beams while others pretty much leave the center gun's green electron beam alone and only affect the outer ones. Various options then exist depending on the magnetic field pattern.

Both purity and static convergence is done by moving three pairs of magnet rings that are located together in the **Concentric Convergence Assembly**. These rings consist of multi-pole magnets which due to their magnetic field pattern are able to affect the electron beams from the three electron guns in different ways. The relative orientation of the magnetic rings in a pair affects the **strength** of the magnetic field pattern produced. And the orientation of the magnetic ring pair together affects the **direction** of the magnetic field pattern produced. The effects can most easily be seen on CRT screen with a crosshatch test pattern.

The first pair of multi-pole ring magnets closest to the CRT screen affects **purity**. The second pair and third pair are for **convergence** and work on pairs of colors (R to B and RB to G).

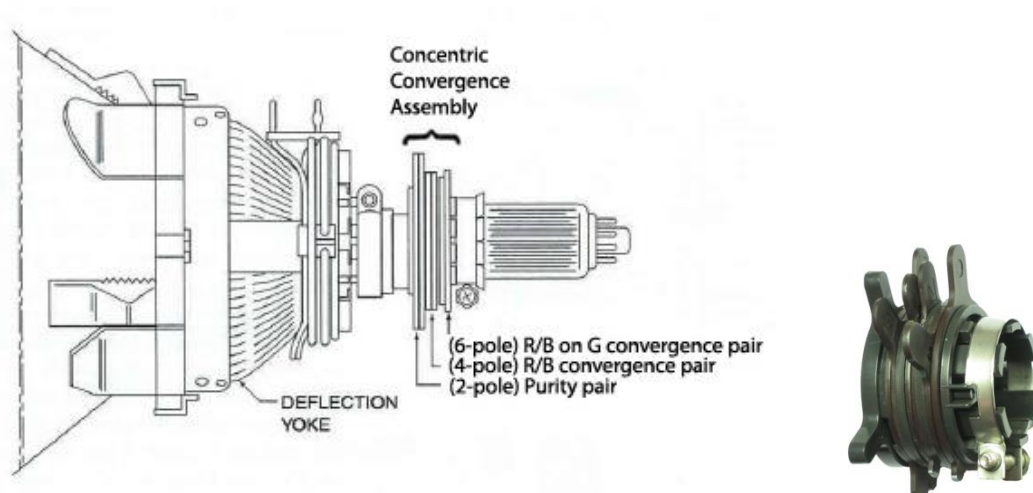

Position of different multi-pole ring magnet pairs on the CRT

HOW TO MOVE ELECTRON BEAMS INDIVIDUALLY

Each magnetic ring set is actually a pair of magnetic rings (a set of rings consists of one ring flipped and put on top of the other ring) which may be moved relative to one-another to control the strength or moved together to control the direction of the magnetic field pattern.



Three pair of magnetic rings (from left 2-pole, 4-pole and 6-pole)

The three sets of ring magnets are shown below along with the position of the red (R), green (G), and blue (B) electron beams passing through them **into the paper**.

Two typical orientations are shown (N and S are the poles of the ring magnets).

Orientation 1:

N	N S	S N
R G B	R G B	N R G B S
S	S N	S N
2-pole (purity) 0 Degrees	4-pole (red-blue) 0 Degrees	6-pole (red/blue-green) 0 Degrees

Orientation 2:

	S	S
N R G B S	N R G B N	N N R G B
	S	S S N
2-pole (purity) 90 Degrees	4-pole (red-blue) 45 Degrees	6-pole (red/blue-green) 30 Degrees

2-Pole

The 2-pole purity rings move the set of RGB beams more or less together to fine tune the position of the center of deflection. The magnetic field lines generally go across between the N and S poles.

Orientation 1: the RGB beams will be moved to the right.

Orientation 2: the RGB beams will be raised.

4-pole

The 4-pole red-blue rings move the R and B beams relative to the G beam but leave the G beam alone. The magnetic field lines generally go between adjacent N and S poles. On opposite sides of the rings, the polarity/direction of the lines opposes and thus tends to move the R and B

beams in opposite directions. The G beam in the center does not experience any deflection from the 4-pole ring magnets since all the magnetic fields tend to cancel.

Orientation 1: the R beam will move up and to the right and the B beam will move down and to the left relative to G.

Orientation 2: the R beam will move up and the B beam will move down relative to G.

6-pole

The 6-pole red/blue-green rings move the RB beams relative to the G beam but leave the G beam alone. The magnetic field lines generally go between adjacent N and S poles. On opposite sides of the rings, the polarity/direction of the lines is the same and thus tends to affect the R and B beams in the same direction. The G beam in the center does not experience any deflection from the 6-pole ring magnets since all the magnetic fields tend to cancel.

Orientation 1: the R and B beams will move up relative to G.

Orientation 2: the R and B beams will move up and to the right relative to G.

THE MULTI-POLE RING MAGNETS IN DETAIL

The description of ring magnets above indicates S poles and N poles only around the circumference. In a closer look we will find that each pole is actually a small magnet. And every magnet has to have two poles!

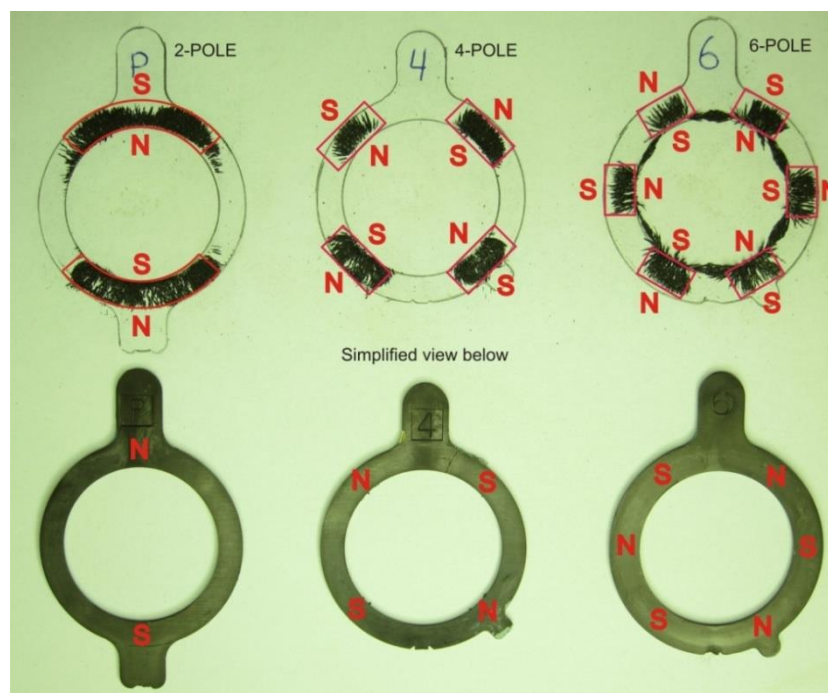

Concentric multi-pole ring magnets with the magnetic field visualized with iron powder.

The small red magnets shown in the picture above have two poles and the total magnetic field pattern is complex in detail. It is good enough to use the simplified view (using only the inner magnetic pole of every small magnet as they contribute the most to the total magnetic field **inside** the rings) when explaining the function of the magnetic rings.

As every set of magnet rings consists of one ring flipped and put on top of the other ring to create a pair. When the two rings in a pair rotates **relative** each other the **strength** of the magnetic field pattern will increase to a maximum (overlap 100%) or decrease to a minimum

(cancellation – 180 degrees with the 2-pole magnet pairs, 90 degrees with the 4-pole magnet pairs and 60 degrees with the 6-pole magnet pairs). When the two rings in a pair are rotated **together** the **direction** of the magnetic field pattern is rotated. When a ring pair is in a cancelling position it is called to be in a “zero-position”. A **zero-position** ring pair will have **no effect** on the electron beams.

Each magnetic ring will often have small and large tabs on the outside. They are used to align the ring pairs to either create a zero-position or a maximum magnetic field strength. But the position of the tabs varies from manufacturer to manufacturer.

DEFLECTION YOKE

The **Deflection Yoke** located around the neck of the CRT is used to electrically move the RGB electron beams in X- and Y-directions on the CRT screen (the physical rotation of the deflection yoke decides the directions of the X and Y axis compared to the physical geometry of the CRT). The position of the deflection yoke will also compensate for some of the different imperfections and manufacturing variations in the CRT. The compensating is done by positioning the deflection yoke back and forth (some degree of color purity adjustments) and tilting (dynamic convergence) [4-degree of freedom]

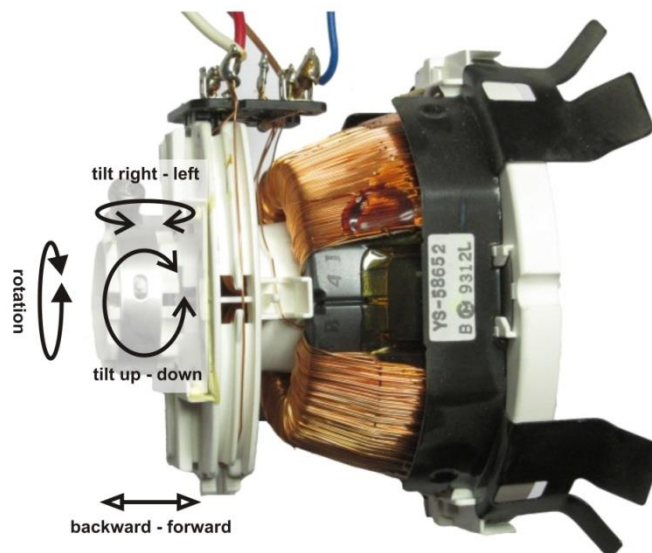

Possible movements of deflection yoke

PURITY

The **lateral position** of the deflection yoke (back and forth on the CRT neck) will affect the overall color purity.

DYNAMIC CONVERGENCE

Dynamic convergence is performed by **tilting** the deflection yoke. Tilting affects the trapezium-effect or/and the linearity of all three colors in the picture.

Dynamic convergence determines the geometric alignment of the three colors in the **outer** part (compared to static convergence that deals with inner part alignment) of the CRT screen. A CRT

is said to be in convergence when all three electron beams (primary colors of R, G and B) overlap in all places on the CRT screen (so white appears as white and nothing else). Misconvergence shows up as color "fringing" around the edges of objects anywhere on the CRT screen.

PICTURE ROTATION

The **rotation** of the deflection yoke affects directly the rotation of the picture.

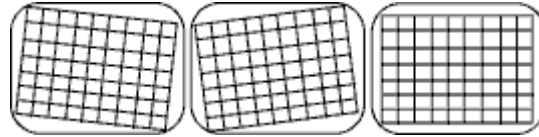

DEFLECTION YOKE IN DETAIL

The deflection yoke consists of two pairs of coils where each pair is connected in electrically series and wound on ferrite cores. The two serial connected X-coils are often referred to as simply the **X-coil** and the two serial connected Y-coils are often referred to as the **Y-coil**. The X-coil controls the X-position (horizontal) of the electron beams and the Y-coil controls the Y-position (vertical).

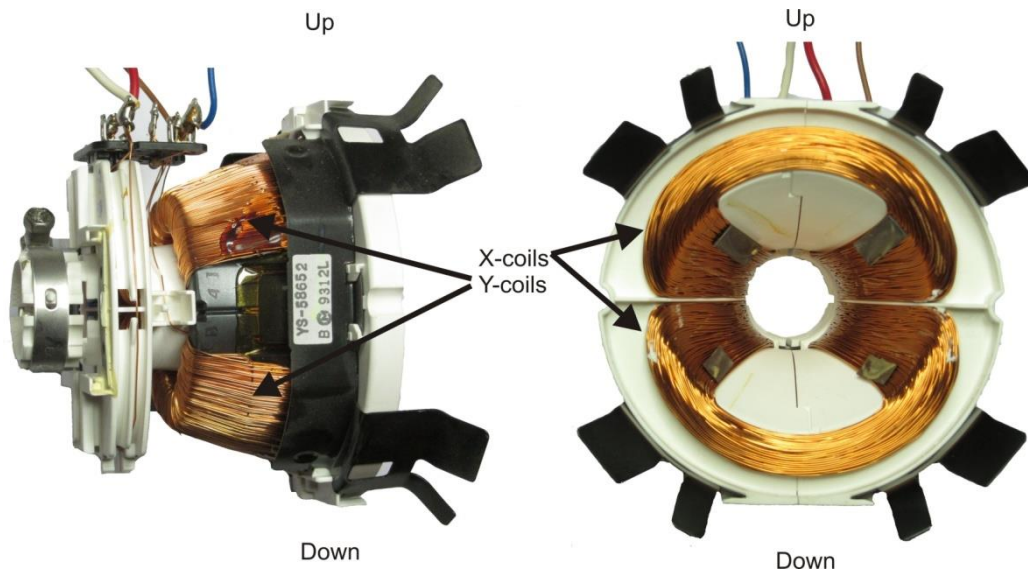

X-coils and Y-coils in a deflection yoke

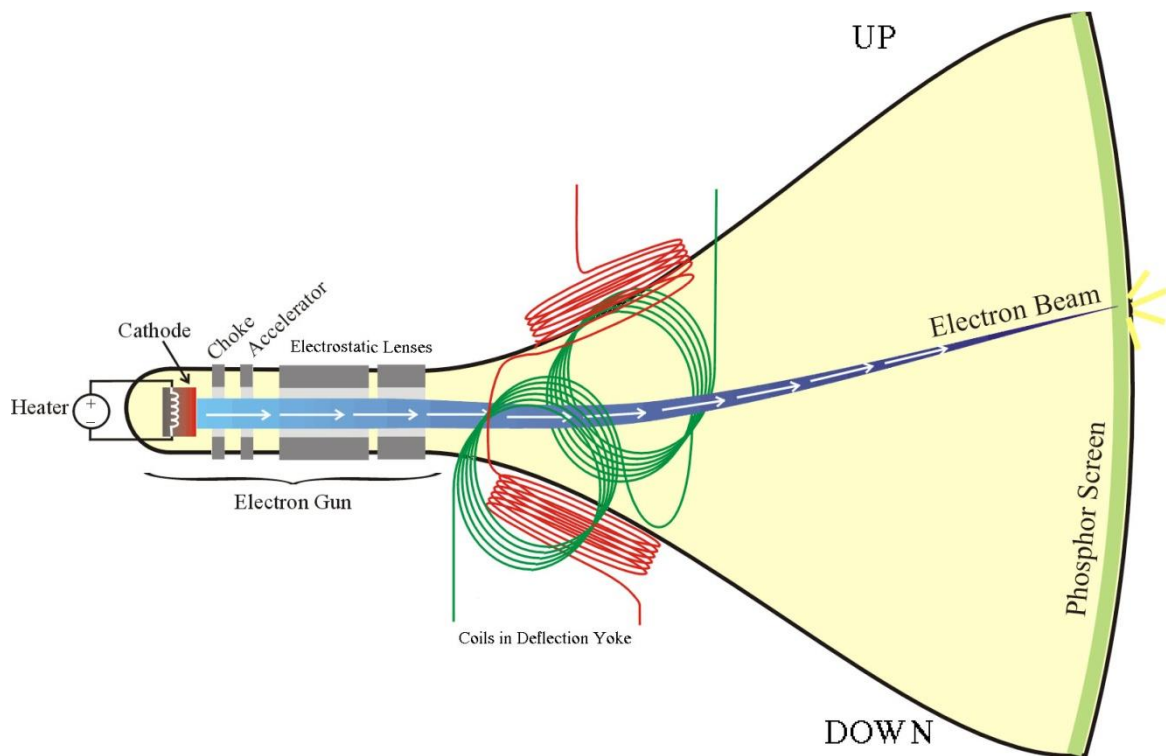

The two red coils represent the X-coil and the two green coils represent the Y-coil

The electrical impedance of the X-coil and the Y-coil is also different. The X-coil has normally a low impedance and the Y-coil has a higher impedance by a factor of 3-5 compared to the X-coil.

DIFFERENT VOLTAGES TO A PAG

A PAG (or in common tongue – CRT ☺) needs to be driven by many different voltages to work properly. This section tries to explain the main voltages used to drive a CRT and the effect they are causing.

THE B+ VOLTAGE

B+ is the name given to the main DC power supply voltage in a monitor (the name B+ goes way back to battery operated vacuum tubes operated radios. The electrodes in a vacuum triode were called A for filament/cathode, B for plate/anode and C for control grid. The associated batteries to these electrodes were then called the same. So, B+ denotes the positive voltage of the “B-battery” that provided positive voltage to the anode of a vacuum triode tube).

The B+ is what the monitor uses to generate various voltages around the board but mainly the high voltage for the flyback transformer. It is generally thought that testing the B+ (since it is the base for all of different systems in the monitor) and seeing if it is low or higher than what it is supposed to be, is a good indicator of what is going on. B+ varies from monitor to monitor, but usually between 100 VDC and 200 VDC. The anode high voltage G4 is **often directly** and only adjusted by changing the B+ voltage.

Here are some examples of B+ voltages in different monitors: WG6100 - 180 VDC; Amplifone - 180 VDC; Sanyo 20EZ - 108 VDC; Electrohome G07 - 120 VDC; WG4900 - 175 VDC (not adjustable).

FLYBACK TRANSFORMER

The flyback transformer is also called FBT (FlyBack Transformer) or LOPT (Line OutPut Transformer). The high voltages required for the CRT's grids and the high voltage anode G4 are derived by the flyback transformer action. There are many circuit designs for flyback transformers but many of them are similar or are variants to this example:

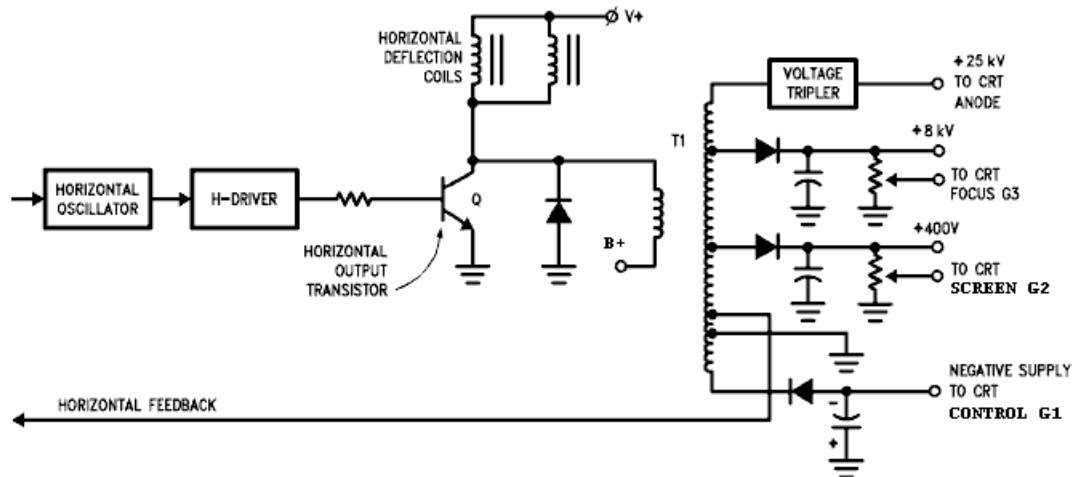

The horizontal output transistor Q not only drives the horizontal deflection coils but it also drives the primary of the flyback transformer T1. During the horizontal retrace interval (the “flyback”), the collector current of transistor Q drops rapidly causing the transformer's magnetic field to collapse. The transformer's T1 primary coil in turn produces a back EMF to sustain the current thus raising transistor Q's collector to a high potential. Through the transformer action, T1's secondary coil produces high voltages. A voltage multiplier circuit consisting of a diode and capacitor network multiplies the secondary coil's voltage to a 25,000V potential that the tube's high voltage anode G4 requires. Other high voltages are derived by tapping various points on the

secondary coil. A diode and capacitor network is used to rectify and filter the power supply voltage. A power supply of this type is often called a scanning or flyback voltage supply because of its association with the horizontal sweep circuit.

COMPLETE ELECTRON GUN INCLUDING THE CRT SCREEN

The voltages to the CRT do many things but can be summarized as;

- creating electrons
- accelerating electrons and forming the electron beam using electron optics
- steering the electron beam (beam deflection)
- producing light at the CRT screen (phosphor)

CREATING ELECTRONS

The electron gun begins with what is often called the "heater". It is a filament of metal (usually tungsten, which is the same material used in everyday household light bulb filaments). This filament heats up a cathode (K), which results in a production of electrons.

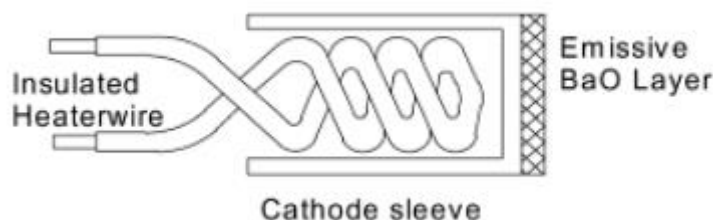

The reasons why this happens are more related to physics than electrical engineering, and therefore are beyond the scope of this document to fully explain, but suffice it to say that when something increases in temperature, the atoms that comprise the material move around faster, and this makes their electrons more prone to flying off into space. This phenomenon is what physicists call "thermionic emission", but you can just think of it as the tendency of metal to throw off electrons when it gets hot.

The filament underlying the cathode structure provides the heat at 800 °C for the older barium-oxide style and up to 1000°C for dispenser types. Barium-oxide cathodes were subsequently improved by adding scandium doping that extended the useful life by approximately 15% over the barium-oxide-only cathodes. The filament is specifically designed to support a cathode temperature when powered at either 6.3 V ac or 12 V dc. Historically, the 6.3 V ac filament dates back to vacuum tubes and car radios when the car electrical systems were 6 V.

The cathode (K) provides a continuous supply of electrons that form a space charge, i.e., an electron cloud, in front of the emitter surface.

From the very start of its emissive life, the cathode is depleting the available electrons. The drive of the video amplifier does not contribute to the electron flow; it is merely a voltage potential that causes electrons to flow at a specific rate. Barium is the source of electrons in both oxide and dispenser cathodes. The process of giving up electrons leaves behind atoms that are now short of valence electrons. This in turn causes cathode material to migrate to the G1 area and deposit itself. Over extended operating times, the migrated material changes the electrical biasing characteristics of the optics, which is observed as black-level drift. The remedy is to periodically adjust the brightness to maintain proper settings for the black level. Cathode aging (or depletion) is a failure mode for all CRT-based displays. There are two basic types of cathode material, with subgroups based on additives (doping) and/or mechanical structure resulting from

manufacturing techniques. The types are oxide or dispenser, even though both utilize barium oxide as the primary source of electrons. The full name for the oxide is barium oxide or scandium oxide, where the scandium is a doping on a barium-oxide cathode. Most CRT applications can use either type of oxide cathode and yield a satisfactory life.

ACCELERATING ELECTRON AND BEAM FORMING

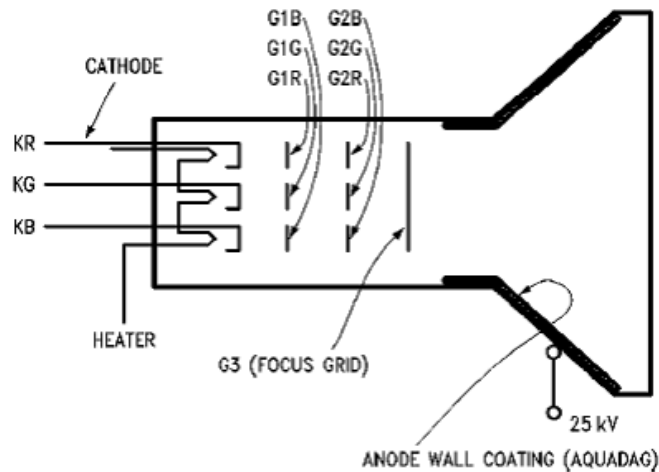

A large DC potential, on the order of several hundred volts more positive than the cathode is applied at the second grid, G2. This causes the electron beam to be accelerated towards the screen. Since the beam emerging from the cathode (K) tends to diverge, a negative potential with respect to the cathode is applied at grid G1. By making G1 (also called control grid) more negative than the cathode, the electron beam begins to converge as shown in the figure above. This action is similar to beam focusing using an optical lens. Furthermore, by modulating the potential difference between the cathode (K) and the control grid (G1), the beam intensity and hence the brightness level is modulated. Finally the beam is electrostatically focused on the screen by adjusting grid G3's potential until the desired focus is achieved.

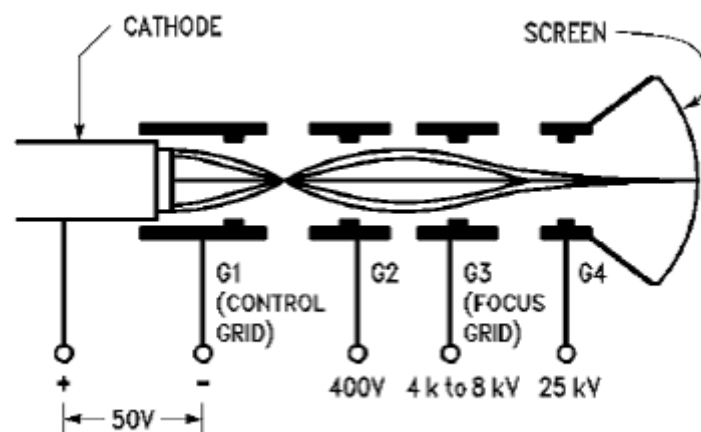

CONTROL GRID – G1

The control grid (G1) controls the brightness of the CRT. It is generally placed directly on top of the cathode (K). If there is no voltage on G1, the electrons can flow freely from the cathode (K). If there is some negative voltage on G1, the electrons from the cathode (K) are repelled somewhat, and the CRT screen appears darker. The greater the negative voltage on G1, the

darker the CRT screen becomes, because more electrons reaching the CRT screen equals a brighter image, and less electrons hitting the CRT screen equals less brightness.

SCREEN GRID – G2

The screen grid (G2) is the first anode and it is always positive in potential relative to the cathode (K) and serves two purposes: to accelerate the beam as it exits G1 and to prevent the higher potential fields of the electron optical lens from penetrating into the G1 space.

The screen grid (G2), also known as the cutoff, serves to "push" the electrons so they travel more quickly toward the CRT screen, in much the same way as blowing in one end of a tube will force something out the other end.

FOCUS GRID – G3

The focus grid (G3) controls the focus (concentration) of the electron beam. This is required to make the beam create a small, sharp point on the CRT screen. If the beam were not in focus, it would create a fuzzy blob on the CRT screen instead. The ratio of the voltage at the (G3) relative to the voltage at the anode (G4) controls the crossover point and therefore the point at which the image is focused, much the same way as the curvature of an optical lens determines its focal point. The focus grid applies a strong (usually a few thousand volts) positive charge to the electrons passing through it.

On some late CRT there exist two focus grids. They are called dual focus CRT and utilizing a DAF (Dynamic Astigmatism Focusing) configuration. One focus grid is called F1 and acts on the horizontal and vertical focus performance and the other focus grid is called F2 and acts mainly on the vertical focus performance. The F2 voltage is often used together with an added dynamic focusing circuit creating a parabolic shaped waveform to a separate focusing coil. This focusing coil creates a magnetic field in parallel to the electron beam. The electrons will circle in helical paths along the parallel magnetic field lines very tightly. So tightly they will appear to be "stuck" on the field lines. When the magnetic field line bunch together - the electrons are focused. If the bunched electrons are pulled out the other side by an electric field (F2 grid) they don't have time to spread out. Thus the electrons will be focused. The focus coil is often place directly after the CCA. These CRT was used mostly in high resolution computer monitors. The simplified function of a dual focus CRT is the same as in a "one" focus CRT. One can see it as there are two focus voltages (F1 and F2) instead of one (G3) ☺.

STEERING THE BEAM (DEFLECTION)

The beam deflection system consists of two sets of electromagnets, one for vertical positioning and one for horizontal. The constellation of these electromagnets together is the yoke.

ANODE – G4

The CRT screen has a plate of some metal (often aluminum) underneath the coating of phosphors; this plate is given a very strong (on the magnitude of several ten thousands of volts) positive charge that pulls the electrons fast toward the CRT screen.

CRT SCREEN

The CRT screen is a plate of glass, coated on the inside with phosphor. When a part of this coating is struck with the electron beam, the phosphors become "excited", and they produce light. The chemical composition of the phosphor determines what color of light it will produce. To make a color CRT screen, phosphors of red, green, and blue are clustered together in one

ELECTRICAL CONNECTIONS TO A CRT

Name	Where	Typical voltage
Heater filament	2 pins on CRT glass neck	6,3 VDC
Red cathode	1 pin on CRT glass neck	0 to +70 VDC
Green cathode	1 pin on CRT glass neck	0 to +70 VDC
Blue cathode	1 pin on CRT glass neck	0 to +70 VDC
Control grid G1	1 pin on CRT glass neck	0 to -50 VDC
Screen grid G2	1 pin on CRT glass neck	+300 VDC
Focus grid G3	1 pin on CRT glass neck	+6 kV DC
X deflection coil pair	2 pins on yoke assembly	
Y deflection coil pair	2 pins on yoke assembly	
Anode G4	1 terminal on upper part of CRT glass bell	+25 kV DC

GEOMETRIC DISTORSIONS IN A CRT

CRT displays are subject to geometric distortion because the electron beam has to travel in a magnetic environment. This is the result of not just the deflection yoke, but also the earth's magnetic field, which varies in strength and orientation around the globe. What is square to the bezel in the Northern Hemisphere will be rotated counterclockwise and moved to the left in the Southern Hemisphere. Incorporating user control to compensate for positional errors is standard, but there are unusual cases where the control authority is exceeded. A facility's other equipment or higher-intensity magnetic fields within the earth's crust (i.e., lodestone deposits) can cause this. The power for a commercial building is contained in conduits running through walls and ceilings. An elevator shaft provides a central location for wide power distribution. Large conduits carrying 3-phase ac for elevators are also split into individual phases for lighting grids. A diagnostic reading room sharing a common wall with the elevator shaft could experience large distortions caused by the fields around the conduit. Color CRTs contain internal shielding against magnetic flux lines to prevent color purity problems. Very small distortions in the multibeam trajectory would be noticed immediately in the form of color variations. Geometric distortions would be secondary to purity for objectionable image quality in color. A special material called Mu metal does absorb magnetic forces, but it is a very expensive solution and is used sparingly only in critical areas, such as around the electron gun structure.

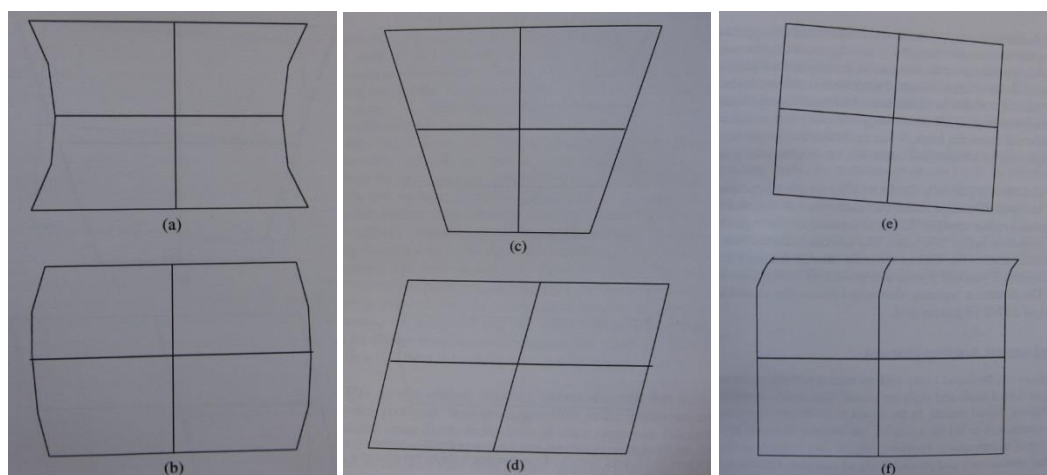

A pincushion distortion (a) is normally associated with the left and right edge representing the video width. The top and bottom edges can also have a similar appearance. Yokes are designed so that they have some pin to the uncorrected geometry. Correction can be accomplished with magnets applied to the yoke housing in a basic system without electronic pincushion correction, or a combination of both. An electronic pincushion would adjust the width by modifying the

horizontal saw tooth waveform. Magnets can also be added to the CRT funnel area with adhesive as a last resort. High-quality yokes require the fewest magnets for correction on all edges. As yoke quality goes down, the number of magnets increases. This is detrimental to the image quality because magnets pull the beam apart in addition to bending it. The combination of a poor yoke and the added magnets is a downward spiral in performance that should be avoided.

A barrel distortion (b) is the opposite of a pincushion and can be thought of as pincushion overcorrection. In a basic system, magnets would need to be removed or rotated to reduce their influence.

A trapezoidal (keystone) (c) distortion is caused by a difference between opposing yoke windings. The trapezoid can be symmetrical or nonsymmetrical. Electronic correction under digital control has the ability to provide asymmetrical compensation and trapezoidal balance.

An orthogonal (d) is a yoke manufacturing error that causes the relationship between the horizontal and vertical windings to be misaligned. The visual cue is the intersection of the vertical and horizontal lines at screen center. Their intersection will be an angle other than 90 deg. Attempts to adjust for this problem induces other distortions in image quality. In a perfect yoke, the beam at screen center is at the magnetic center of both windings. Disparity between the windings means the beam can no longer remain at the magnetic center of both. The more severe the disparity, the worse the net result.

Tilt (e) is a simple rotational change in the entire image. At the time of manufacture, the yoke must be installed and aligned to the CRT. It is held in place by a mechanical clamp on the CRT neck and hot glue at the funnel. A display rotation that is due to earth's magnetic fields should be within the corrective range of a tilt adjustment. A rotation coil can be integrated into the yoke housing or attached to the CRT funnel. This is nothing more than a loop made from a continuous wire with a small current applied.

A hook (f) is found at the top of the vertical lines, with the upper left corner typically being the most severe area. It is caused by cross talk between the vertical and horizontal windings at the juncture of the retrace for both sweeps; i.e., both magnetic fields have been collapsed (reversed) to initiate the next frame. If insufficient time is available to stabilize the horizontal sweep circuits (which include the yoke windings), inductive energy from the vertical and collapsing horizontal fields will cause the hook. Video cards that do not provide blanking time at the beginning of a frame can cause this on an otherwise good-quality display. Inner line distortion is primarily a yoke winding distribution problem and/or a CRT with a compound internal radius that cannot be compensated for by the yoke. A compound radius changes the throw distance (a gun to screen) for the beam from one radius to another, and this can occur on both the horizontal and vertical axes of the CRT at different rates of change.

MONITOR CONVERGENCE "THE LEAN WAY"

If you are somewhat familiar with monitor convergence procedures you can use this section as it summarizes most parts of it in a condensed format. The text was originally written by James Dinndorf and published on www.arcaderepairtips.com. I have deliberately omitted parts from the original text which did not actually add anything important. Thanks James!

MONITOR CONVERGENCE TIPS

Just a note before we begin. The monitor needs to be powered on during this process so that you can see the changes as they happen. In other words, you'll be able to see the grid lines shift as you move the strips around under the yoke, against the tube. I had a buddy help by holding a mirror, but I also did some of it with the monitor outside of the cabinet. Please be VERY careful.

The first thing to note is that there are actually TWO types of convergence you need to adjust: static and dynamic. The first is static and is the easiest. This is where you use the convergence “rings” on the yoke. Using the game’s test screen, you have it display a grid pattern. Then, using two of the rings, you adjust the red and blue vertical lines until they overlap one another. Then you adjust the red and blue horizontal lines until they overlap. Once this is done, you adjust the rings in order to get the red and blue to overlap the green lines. The monitor manual usual describes this very well and also has illustrations. This process is actually much simpler than most people think but it can be a little intimidating at first. Once done, you can use a marker to mark all of the rings for reference.

Next is the tricky part: dynamic convergence. Whereas “static” convergence covers mostly the inner area of the monitor/screen image, dynamic convergence covers the outer area, particular the edges. For example, if you had white text running across the entire monitor, you might notice that while the letters at the center of the CRT screen look fine, the letters on the far left and right looked “ghosted” with shades of red, blue and green above and below. This is dynamic convergence that needs adjusting.

Adjusting this takes a TON of patience (as I found out) and the worst part is that a lot of it is simply trial and error. Whereas with static convergence, you use the rings on the yoke, dynamic convergence involves adjusting HOW the yoke rests on the tube itself. Again, the monitor manual usual has a great description for a starting place. For myself, I loosened the yoke and played with it a bit, tilting and shifting it while looking at the crosshatch pattern on the monitor. Eventually you should be able to find a “sweet spot” where 75-90% of the edges and rest of the grid line up properly. This is where you want to set your rubber wedges (i.e. those little strips you see sticking out of the yoke) and mount them in place so the yoke rests there. Once that’s done it’s all fine tuning using the little strips to fix the corners and possibly some of the very fine edges. That’s how it worked for me.

After the static convergence, I played with the yoke with no wedges until I found that 85% of the grid looked good. At that point, I set the wedges in to hold it there. I actually used a few extra from another CRT tube which gave me five wedges total. Then I made a bunch of homemade convergence strips (see the note at the bottom for description) and slid them underneath the yoke and against the tube. These strips are about 6-7 inches in length and the end with the blade attached is what slides under the yoke, with the other end sticking out. You will need to tape these in place or use some other form of (strong) adhesive so they stay in place. They’re used to correct specific small areas (i.e. a corner or edge) that require fine tuning. After a lot of patience, I finally got the corners looking good. I had to experiment a bit to get the very top edge to line up all the way, but got it after some time. I ended up constructing a convergence strip that used a piece of metal that was twice as long as the others. That for some reason did the trick.

In the end, the convergence on this thing was about as good as it gets and I’m really happy with it. I’ll admit that the area around the yoke looks terribly ugly as I used a ton of tape and adhesive to reinforce and hold all of the wedges and strips in place but the image is what really matters. Hopefully, this can provide some helpful guidance for those of you that want to adjust the convergence of their monitors but are too intimidated to try especially in this era where CRTs are at an all-time scarcity.

NOTE: To make homemade convergence strips, you can simply go to your local hardware store. Buy a cheap razor blade, preferably one that has a long blade that you press up, notch by notch. Also buy some thin but solid cardboard to use for the strip itself. I bought a cheap yard sign for this. All you have to do is carefully break off a piece of the razor blade about the size of a dime. Cut a small strip of cardboard and attach the piece of razor blade to the cardboard strip using electrical tape. That’s all. You can experiment with the size of the piece of razor blade you use on each strip. Sometimes I found I needed more or less depending on where I was placing the strips.

HORIZONTAL CENTERING (PURITY)

The outcome from adjustments for horizontal centering and purity is the same! But it needs to be done slightly differently in a vector monitor compared to a raster monitor. A vector monitor will never display a homogenous color in the picture as it is built up only of interconnecting lines compared to a raster monitor. It is called horizontal centering in a vector monitor due to what the picture will look like during the actual adjustments. A raster monitor is capable of displaying a whole screen of just one color and it should not show any other colors. Any color distortion is removed during adjustment. It is called purity in a raster monitor because you “remove” any color distortion and make it “pure”.

CRT screen color purity is normally the first CRT setup adjustment to be made, but it does not normally drift very much over time and therefore does not require routine adjustment.

For best results, it is recommended that all CRT adjustment is done with the CRT screen facing south or north.

For purity to be perfect (or as good as possible), the electron beams must originate from the same effective center of deflection as used in originally laying down the phosphors. Moving the deflection yoke forward and backward on the neck of the CRT can precisely set the deflection center along the axis of the neck. However, slight transverse errors may still exist due to imperfections in the deflection yoke coils or positions of the electron guns. This is affected slightly by the earth's magnetic field as well. The purity magnet rings are those closest to the deflection yoke and provide the means for moving the electron beams very slightly to compensate.

Remember that horizontal centering will have an effect of the static and dynamic convergence and vice versa. Therefore is it important the check the purity after static or dynamic convergence is done.

VECTOR MONITOR

Obtain a green crosshatch test pattern video signal. Let the monitor warm up for a minimum of 15 minutes.

Loosen the deflection yoke clamp and move the deflection yoke as far back as it will go – towards the concentric convergence assembly. If there is any glue or tape holding it, it may be necessary to gently twist the deflection yoke to break it loose from the CRT. A wide green vertical band will appear in the center of the CRT screen.

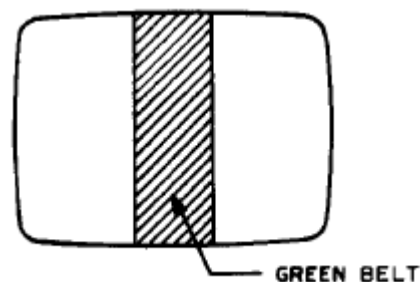

Adjust the purity magnet rings so that the green band is horizontally equal to the red and blue bands on either side. The purity magnet rings must **only** affect the horizontal centering of the display. If they have a vertically or diagonal centering effect, rotate the purity magnet rings together so they only have a horizontal centering effect when the two purity magnet rings move relative each other.

Then slide the deflection yoke forward until the crosshatch test pattern is all green. Continue the forward movement of the deflection yoke until other color just begins to show on the display. This is the forward purity-adjustment limit of the deflection yoke. Slide the deflection yoke back towards the CCA, through the position of pure green crosshatch display, to the point where the display again just begins to show other colors. This is the rear purity-adjustment limit of the deflection yoke. Position the deflection yoke to the middle of the forward and rear purity-adjustment limits. Make sure the deflection yoke is straight (rotational misalignment will cause the picture to be tilted). Re-install any rubber wedges to stabilize the deflection yoke position and then gently tighten the deflection yoke collar clamp.

It is a good idea to then check the red purity, then the blue. Slight adjustments of the purity magnet rings or deflection yoke position may be required to optimize the purity of each of the three color fields. Some compromise may be necessary, but it is usually not important to get it perfect. It has to be pretty far off to show up on a white screen.

RASTER MONITOR

The adjustment procedures generally use the red gun for the setting purity in a raster monitor. Intuitively, one would think this should be the center (green) gun. However, since the red electron beam current is the highest (red phosphor is least sensitive) the landing error will give the best visible discoloration (better than blue and much better than green). So problems are likely to show up first with the red purity so it is used for the adjustment. In any case, it is a good idea to check all three colors for proper purity and tweak if needed before moving on to static convergence.

With **no** video signal input to the monitor turn up the BIAS control for red to max and turn down the BIAS controls for blue and green to minimum so that you have a pure red raster (see section *Controls* and *CRT Transfer Characteristics*). Let the monitor warm up for a minimum of 15 minutes.

Loosen the deflection yoke clamp and move the deflection yoke as far back as it will go – towards the concentric convergence assembly. If there is any glue or tape holding it, it may be necessary to gently twist the deflection yoke to break it loose from the CRT. A wide red vertical band will appear on the CRT screen. Adjust the purity magnet rings to center the red vertical raster on the CRT screen.

Then slide the deflection yoke forward just enough to get an overall red screen without contamination by green or blue. Use a crosshatch test pattern to make sure the deflection yoke is straight (rotational misalignment will cause the picture to be tilted). Re-install any rubber wedges to stabilize the deflection yoke position and then gently tighten deflection yoke collar clamp. Reset **all** BIAS controls you touched to get a red raster.

It is a good idea to then check the green screen purity, then the blue. Slight adjustments of the purity magnet rings or deflection yoke position may be required to optimize the purity of each of the three color fields. Some compromise may be necessary, but it is usually not important to get it perfect. It has to be pretty far off to show up on a white screen.

STATIC CONVERGENCE

Static convergence is normally done after the horizontal centering adjustments, but it is often beneficial to "roughed in" the static convergence adjustments before horizontal centering because they interact with each other somewhat. Often it is best to go back and forth between static convergence and horizontal centering to obtain the optimal setup.

A CRT is said to be in convergence when all three electron beams (primary colors of red, green and blue) overlap in all places on the screen. The static convergence will adjust the color overlap only in the **center** of the CRT screen and dynamic convergence will adjust the color overlap only in the **outer** parts of the CRT screen. Any misconvergence often shows up as color "fringing" around the edges of objects anywhere on the CRT screen.

All static convergence is done by displaying a white crosshatch test pattern on the CRT screen and adjusting two multi-pole ring magnets pair on the CCA. All multi-pole ring magnet rings have tabs on them and the two tabs in a magnetic pair can be moved closer together or farther apart or moved together (keeping the same distance).

The position of the 4-pole magnet rings (the second ring pair after the deflection yoke) affects two specific colors only, moving them apart and bringing them nearer, while leaving the third color alone.

The position of the 6-pole magnet rings (the third ring pair after the deflection yoke) takes the colors affected by the 4-pole magnet pair, and moves them together relative to the third color.

Of course these adjustments interact with each other, so you need to look carefully and see what happens on the CRT screen, and go back and forth between the two settings for optimal convergence. It takes very little movement of the rings to affect the picture you see on the CRT screen.

4-POLE MAGNETIC PAIR

The position of the 4-pole magnet pair will affect the red and blue lines at the **center of the screen only**.

Rotating the magnet rings relative each other will move the red and blue together until they coincide vertically (creating magenta vertical lines):

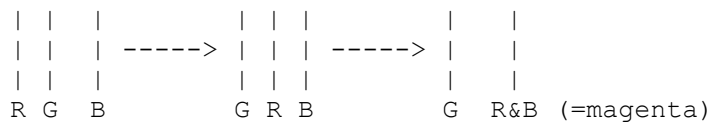

Rotating the magnet rings together will move the red and blue together until they coincide horizontally (creating magenta horizontal lines):

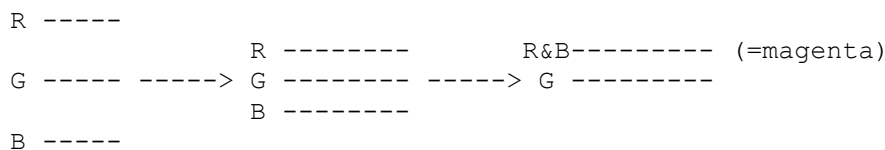

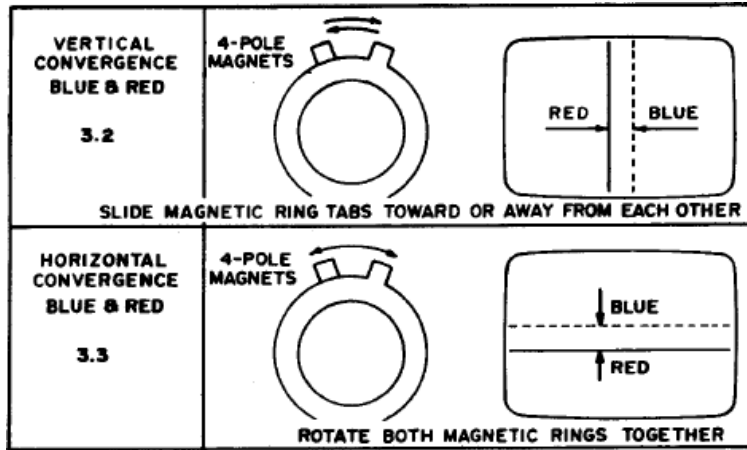

6-POLE MAGNETIC PAIR

The position of the 6-pole magnet pair will affect the magenta (red + blue) and green lines at the center of the screen only.

Rotating the magnet rings relative each other will move the magenta (red + blue) and green together until they coincide vertically (creating white vertical lines):

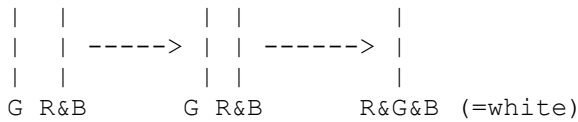

Rotating the magnet rings together will move the magenta (red + blue) and green together until they coincide horizontally (creating white horizontal lines):

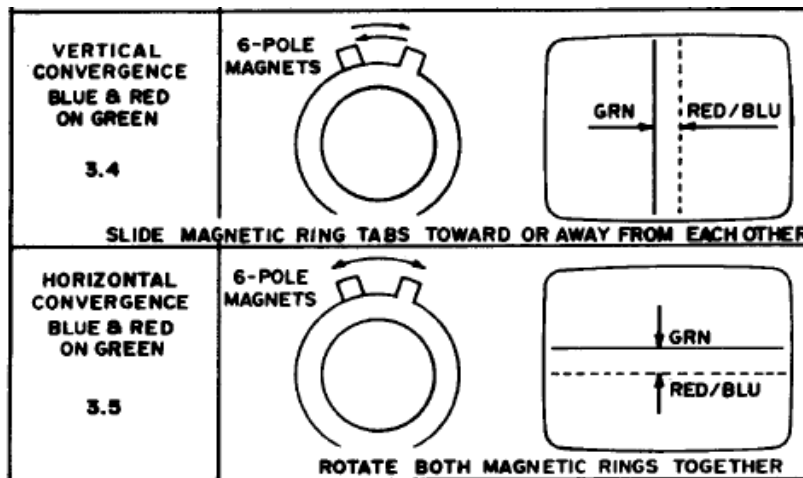
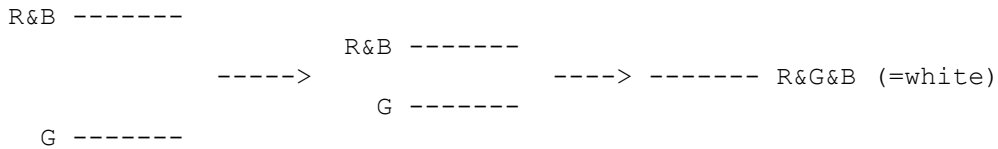

DYNAMIC CONVERGENCE

Dynamic convergence is normally done after the static convergence. A CRT is said to be in convergence when all three electron beams (primary colors of red, green and blue) overlap in all places on the CRT screen. The dynamic convergence will adjust the color overlap only in the **outer** parts of the CRT screen. Any misconvergence often shows up as color "fringing" around the edges of objects anywhere on the CRT screen.

All dynamic convergence is done by displaying a white crosshatch test pattern on the CRT screen and adjusting the tilt of the deflection yoke.

Tilting the angle of the deflection yoke up and down adjusts the crossover of both vertical and horizontal red and blue lines.

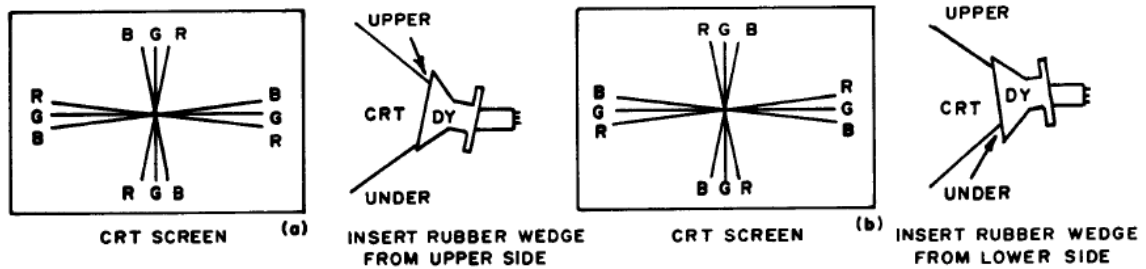

Tilting the angle of the deflection yoke sideways (right/left) adjusts the parallel convergence of both horizontal and vertical lines at the edges of the CRT screen.

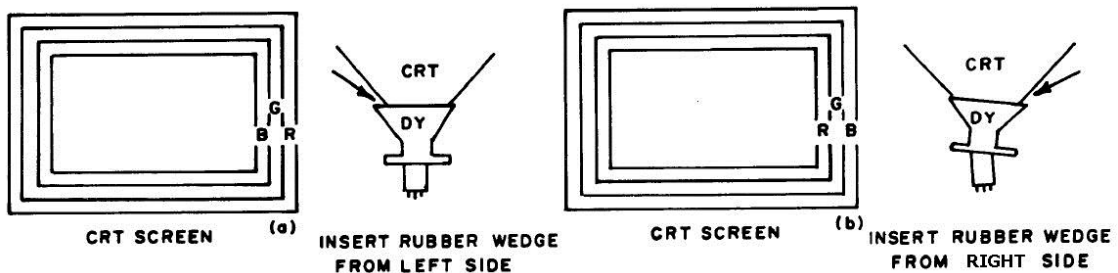

Of course these adjustments interact with each other, so you need to look carefully and see what happens on the CRT screen, and go back and forth between the two settings for optimal convergence.

PROCEDURE

The deflection yoke is anchored to the CRT neck by the collar clamp; loosen this slightly but not enough so that the deflection yoke can move backward or forward. It is also held in place by rubber wedges glued or taped down to the CRT tube. Take the rubber wedges out. By gripping the deflection yoke and levering it up and down, left and right, you will change the convergence in **outer parts** of the CRT screen.

When you have the deflection yoke where you want it, tighten the collar clamp again (pay attention to how many turns you loosen it, and tighten it the same number of turns). Also use temporary rubber wedges around the outer perimeter of the deflection yoke to help you to secure the correct tilting position.



Rubber wedges

Recheck the horizontal centering and make any necessary re-adjustments of the deflection yoke.

Insert three other permanent rubber wedges (do **not** force them in) carefully to the CRT glass bell spaced 120 degree from each other. Fix them to the CRT glass bell by gluing them with silicone rubber sealer or a hot glue gun.

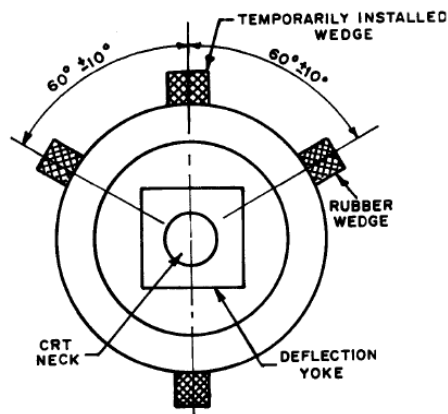

Placing rubber wedges

Carefully remove any temporary rubber wedges when glue has sealed.

TRACKING (WHITE BALANCE)

The goal of this adjustment is to ensure that a high intensity white signal (all RGB-electron beams on high current) is actually perceived white on the CRT screen and a low intensity white signal (all RGB-electron beams on low current) is also perceived white (dark gray) on the CRT screen. Or in other words - all shades of gray should be perceived as "neutral" gray. This setup procedure is also called black and white tracking, color balance, white balance, CRT tracking, or just greyscale adjustment.

CONTROLS

There are two sets of controls per color to set the picture highlights and lowlights separately. These controls set the voltage levels that appear on each of the three color "guns" of the CRT. The highlights or bright areas of the picture are set with the GAIN (or "drive" or "background") controls, and the lowlights are set with the BIAS (or "cut-off") controls.

There are also controls for FOCUS ("focus grid" or "G3"), MASTER SCREEN ("screen grid" or "G2"), BRIGHTNESS ("control grid", "G1" or "brightness preset") and MASTER CONTRAST. The FOCUS and MASTER SCREEN are always located on the HV-transformer. See section *Different Voltages to a* for more information.

The FOCUS control sets the "fuzziness" or focus of the picture.

The MASTER SCREEN is a **very** coarse adjustment that sets the overall level of brightness. As a tube ages, the G2 may need to be set higher to compensate for a low-brightness problem. If this control is set too high, the picture may be too bright and/or take on a milky appearance with faint diagonal "retrace" lines in the picture of a raster monitor. If set too low, you will not have enough brightness even with the BRIGHTNESS control at maximum.

The BRIGHTNESS and/or CONTRAST controls are not always present in a monitor.

CRT TRANSFER CHARACTERISTICS

A CRT has a transfer characteristic where the input is the video signal (voltage signal to the electron beams) and the output is the luminance (which is proportional to intensity) on the CRT screen.

CONTRAST

The contrast control applies a scale factor (GAIN) to the red, green and blue signals individually. Contrast control determines the luminance produced for white, with intermediate values toward black being scaled appropriately. **Contrast primary affects the high luminance parts of the picture.**

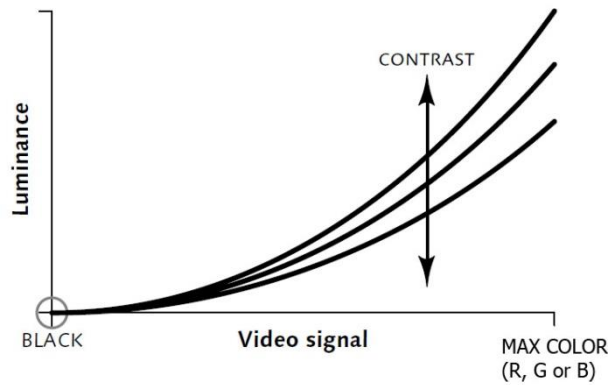

BRIGHTNESS

The brightness control adds or subtracts an offset or BIAS into the red green, and blue signals individually. Brightness control has the effect of sliding the black-to-white video signal scale left and right along the power function of the display. **Brightness primary affects the low luminance parts of the picture.**

When the brightness control is set **too high**: a certain amount of luminance is produced at zero video signal level. No video signal can cause true black to be displayed: the picture content rides on an overall pedestal of gray.

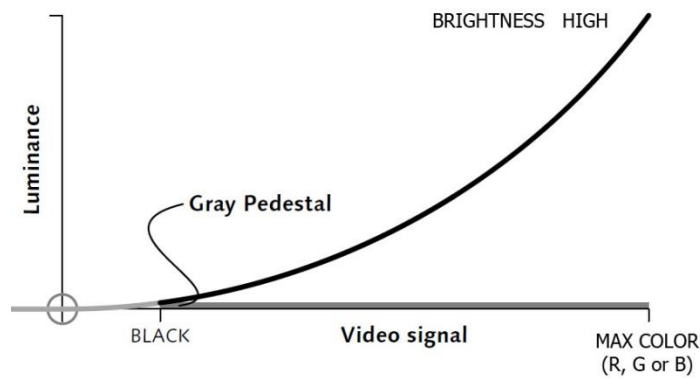

If the brightness control is set **too low**: it will cause a range of input signal levels near black to be reproduced indistinguishably as black.

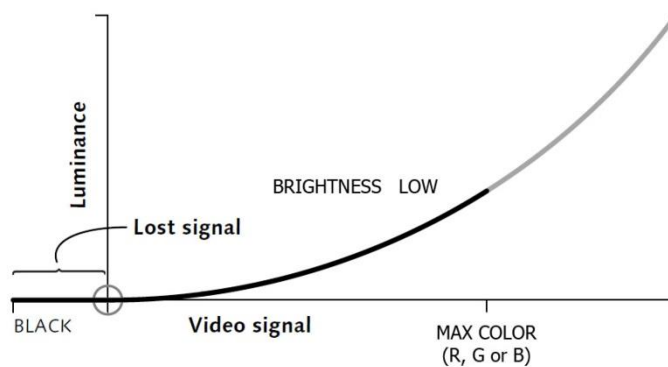

Brightness control is set **correctly** when the black video signal level is placed precisely at the point of minimum perceptible light output on the display. In a perfectly dark viewing

environment, the reference black signal would produce zero luminance; however, in practice the setting is dependent upon ambient light in the viewing environment.

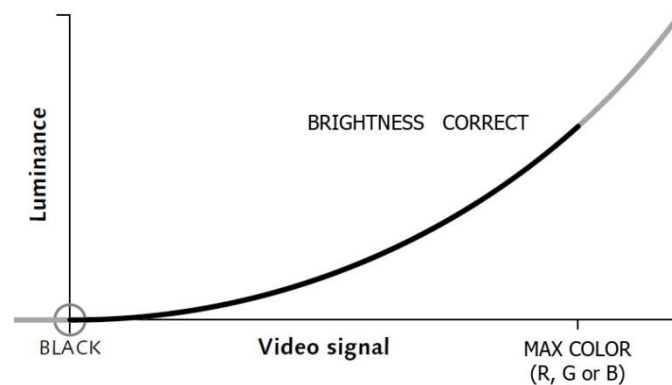

PROCEDURE

See to that purity adjustments and degaussing is done **prior** to any white balance adjustments! The monitor to adjust should be located in a dimly lit room. This is to ensure that observation is done correctly for the dark parts of the picture during adjustment.

Apply a white crosshatch test pattern to the monitor

- Set all BIAS controls (R-BIAS, G-BIAS, B-BIAS) and GAIN controls (R-GAIN, G-GAIN, B-GAIN) to a mid-position.
- Set MASTER SCREEN “enough” high so the crosshatch test pattern is visible without “blooming” too much.
- Set the BRIGHTNESS control and the MASTER CONTRAST to a mid-position, if they exist.

Set the FOCUS control until you get the optimum picture sharpness possible.

Apply a test pattern to the CRT screen that displays different intensity areas of white (from bright white – highlight to the dimmest white - lowlight).

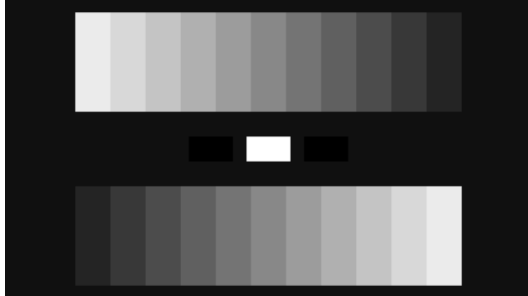

test pattern for a raster monitor

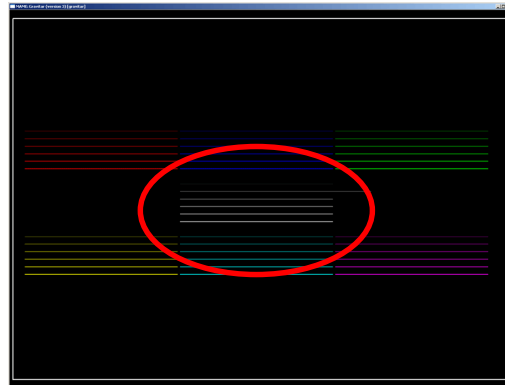

6 line test pattern for a vector monitor

- Set all BIAS controls (R-BIAS, G-BIAS, B-BIAS) and GAIN controls (R-GAIN, G-GAIN, B-GAIN) to a min-position.
- Set MASTER SCREEN to a minimum.
- Set the BRIGHTNESS control to max (this is to lower the strain on the HV-transformer – to keep G2-voltage as low as possible) and the CONTRAST to a low position (10-20%), if they exist.

Turn the MASTER SCREEN up until the black parts of the display are barely becoming gray. Turn the MASTER SCREEN back again until the black parts just become black again.

Adjust the R-BIAS, G-BIAS and B-BIAS controls until the dimmest white area is pure white, without any hint of color in it (color bias abnormalities are most visible at lower brightness levels; the goal is to get all intensity areas to be completely white).

Adjust the R-GAIN, G-GAIN, and B-GAIN controls until the brightest white area is pure white, without any hint of color in it. Repeat the BIAS adjustment if the dimmest white area is no longer pure white.

So, GAIN adjusts the neutral white and BIAS adjusts the neutral black (dark grey).

You may have to make minor adjustments to both sets of controls (GAIN and BIAS) so all levels of brightness are a neutral grey when you are done. Change the BRIGHTNESS control back and forth to see if the all intensity areas "track" properly (does not change color of neutral grey).

OPTIMIZING PURITY IN A RASTER MONITOR

A CRT may have suffered internal distortion or dislocation of the aperture grille making ordinary purity adjustments not sufficient. This approach will work for slight discoloration that cannot be eliminated through ordinary purity adjustments or degaussing.

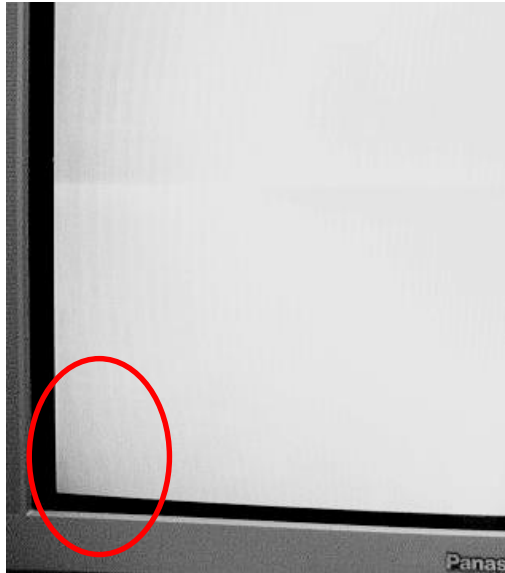

Example of discoloration

The addition of some moderate strength magnets carefully placed on the CRT can reduce or eliminate the remaining purity problems. The types of magnets we will use are sold as **refrigerator magnets** (magnetic strips) and the like for sticking up notes on steel surfaces. These will be made of ferrite material (without any steel) and will be in the form of discs or rectangles.

PROCEDURE

The magnet strips should be placed on the CRT glass bell at least 100 millimeters away from the outer perimeter of the deflection yoke - preferably near the front of the CRT screen. Placing magnetic strips too close to the deflection yoke causes geometric distortion! Experiment with placement, by moving the magnetic strip around so the impurity is minimized or eliminated, using masking tape to hold them in place temporarily. Degauss periodically to evaluate the status of your efforts. Then, make the 'repair' permanent using duct tape or silicone sealer or other household adhesive.

WARNING

- *Do not place magnetic strips too close to the deflection yoke!*
- *Care should be taken to avoid using big magnetic strips!*
- *Do not overuse magnetic strips. Use as few as possible!*
- *Do not use a white raster signal to check for purity because it can be confused with impurity! Use a red video test signal first then recheck with blue and green.*

OPTIMIZING DYNAMIC CONVERGENCE

If dynamic convergence cannot make it “good enough” in the **outer** corners (it might be on the sides also but not very common) one can try optimizing the convergence with yoke strips.

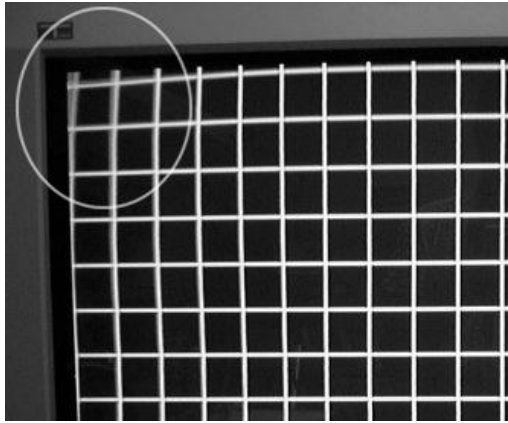

Original

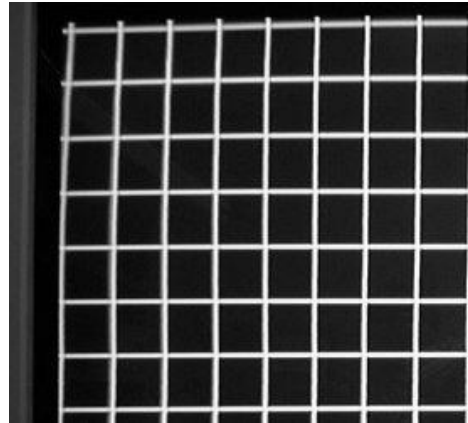

After using yoke strips

PERMALLOY STRIP

The strips have many names such as permalloy strip, yoke strip, magnetic strip, yoke tab, convergence strip, magnetic shunt, magnetic tab etc. A yoke strip is a plastic strip with a permalloy metal on one end and an adhesive patch on the other end.

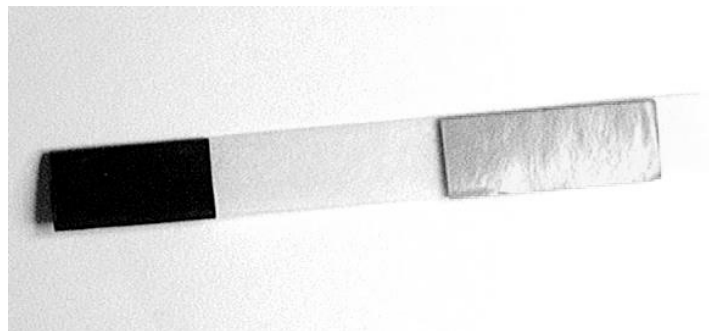

Permalloy strip

Permalloy is an alloy of nickel-iron magnetic, with about 20% iron and 80% nickel. It is remarkable for its very high magnetic permeability of about 100,000, compared to several thousand for ordinary steel. Permalloy has a relative low magnetic remanence (the ability to retain a residual magnetism after a magnetic field has been removed).

To make your own yoke strips you simply use plastic strips and pieces of box cutter blades. Use electrical tape to hold and insulate the blade piece at the end of the strips. Then use double sided tape at the other end.

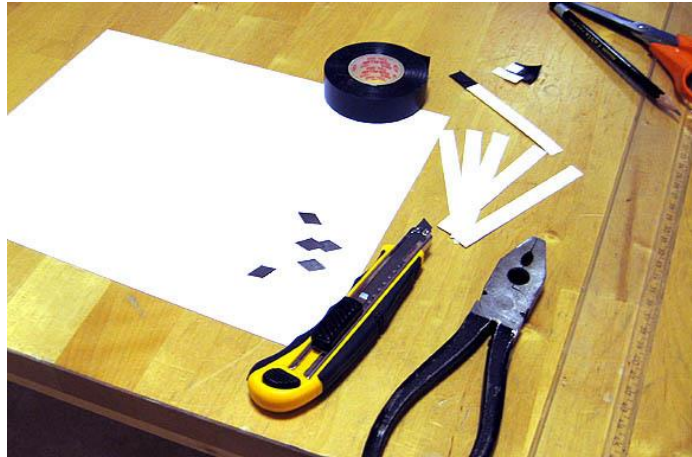

Making yoke strips

PROCEDURE

First degauss all yoke strips with an external degaussing coil!

Use a **white** crosshatch test pattern on the CRT screen. Slide a yoke strip between the deflecting yoke collar and the CRT glass neck and slowly move it around in the same corner as the bad convergence on the CRT screen while observing the white crosshatch test pattern. When you are satisfied with the convergence in that corner, stick the yoke strip to the CRT glass neck with a tape.

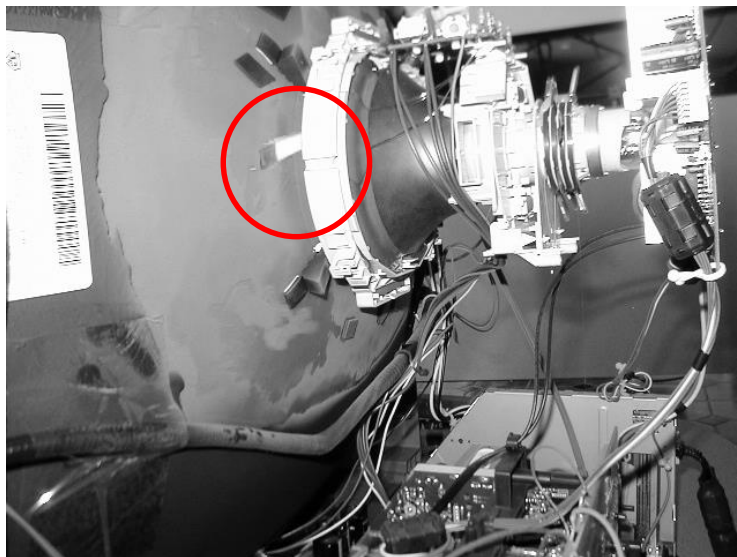

It may need more than one yoke strip to give the appropriate result on the display!

WARNING

Avoid using too many yoke strips as they affect the geometry of the picture!

SETUP PROCEEDURE OF A WG19K6100 MONITOR

If a video test pattern, used during adjustments, is not uniformly displayed it may be necessary to make a coarse adjustment of X and Y size and position. Controls for these adjustments are located on the game board. Check the appropriate game documentation.

Remember that X always refers to the long part of the CRT and Y refers to the short part of the CRT. This becomes highly evidently for the vertically mounted monitor in a Tempest cabinet.

COARSE PROCEDURE OUTLINE

1. Initial Setup – brightness and focus
2. Degauss – de-magnetize the CRT with an external degaussing coil
3. Horizontal Centering – adjust purity magnets and deflection yoke position
4. Static Convergence – converge red and blue and green in center of the display
5. Dynamic Convergence – converge red and blue and green at the edges of the display
6. Degauss – de-magnetize the CRT with an external degaussing coil
7. Tracking – adjust gray and white brightness tracking
8. Optimizing Dynamic Convergence

Note: step 3, 4 and 5 adjustments interact.

INITIAL SETUP

1. Make sure that the monitor is in **full** working order without any issues (HV is set to 19,5kV etc.). This is very important! Otherwise adjustments may not have the desired effect and you will end up with a wacky monitor.
2. Apply power to the monitor and let it warm up for a minimum of 15 minutes. Display a white crosshatch test pattern.

If the neck board is a P328 version set the BRIGHTNESS control (R535) to a 2/3 CW rotation from the end CCW position.

3. **Make a coarse adjustment of brightness.** Adjust the MASTER SCREEN control until the black parts of the display barely becomes gray and then turn the MASTER SCREEN control back until the black parts just become black again.

If there are problems getting a white crosshatch test pattern or adjusting the brightness of the display, check the settings of BLAS controls and DRIVE controls first. Make a coarse adjustment of the tracking as described in section Tracking if necessary.

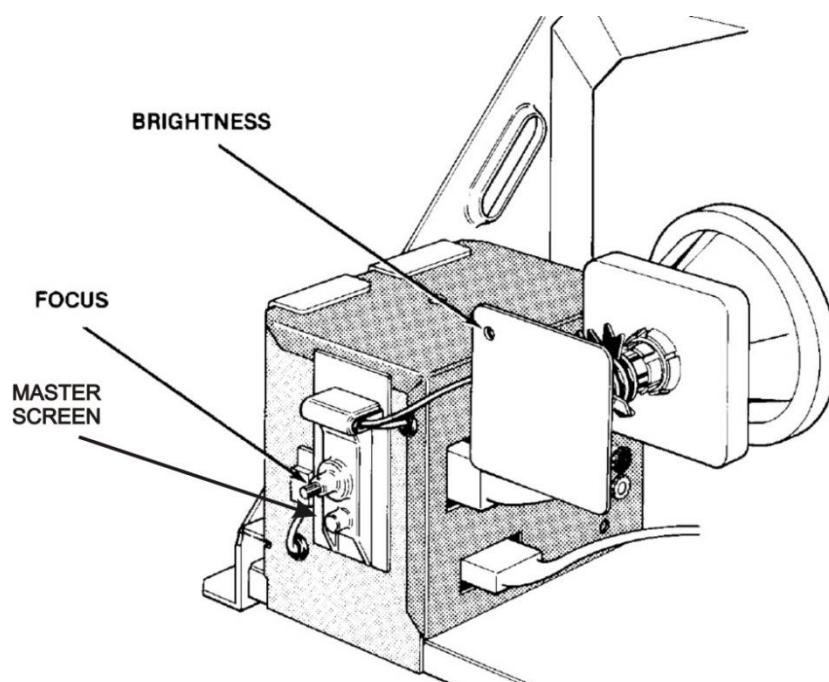

4. Turn the FOCUS control until the crosshatch test pattern has optimum sharpness.
5. Loosen the screws securing the deflection yoke and CCA to the CRT neck clamps.
6. Using a razor blade or thin knife, carefully loosen the glue holding the three rubber wedges beneath the deflection yoke collar. Remove these wedges.
7. Position the CCA so that the purity magnet rings (2-pole) are positioned as closely as possible over the gap in the gun assembly. This is about 2 inches forward from the start of the CRT neck glass.

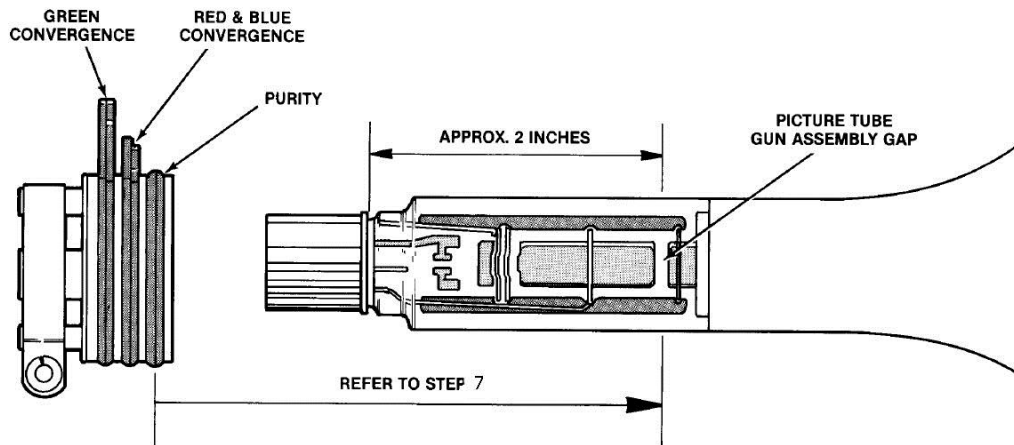

8. Secure the CCA in position by tightening the neck-clamp mounting screw. Remove any glue that may be holding the magnet rings in place.
9. Set the magnetic rings on the CCA in a zero-position.



Zero-position for the CCA on a RCA 19VLUP22 CRT

10. Remove the power from the monitor.

HORIZONTAL CENTERING (PURITY)

1. Position the monitor so that the display faces either east or west.
2. Apply power to the monitor and let it warm up for a minimum of 15 minutes.
3. Degauss the CRT with an external degaussing coil (see section *External Degaussing Coil*).
4. Display a white crosshatch test pattern on the display.
5. **Make a course setting of the static convergence.** Preset the two convergence magnetic ring pairs to superimpose red, green and blue lines (creating white lines) at the center of the display (see section *Static Convergence*).
6. Display a green crosshatch test pattern on the display.
7. Slide the deflection yoke towards the CCA to produce a vertical green band within the center of the crosshatch test pattern.
8. Spread or close the purity magnet rings (2-pole), with respect to each other (the point between the two magnet rings should always be stationary), so that the green band is horizontally equal to the red and blue bands on either side.

*Note for step 8: The purity magnet rings must only affect the horizontal centering of the display. If they have a vertical or diagonal centering effect, rotate the purity magnet rings as a pair **together** (without changing the angle of one magnet ring relative to the other) until a **relative** movement (as in step 8) between the two purity magnet rings **only** affects the horizontal centering.*

9. Slide the deflection yoke forward until the crosshatch test pattern is all green. Continue the forward movement of the deflection yoke until other colors just begin to show in the crosshatch test pattern. This is the **forward purity-adjustment limit** of the deflection yoke.
10. Slide the deflection yoke back toward the CCA; through the position for pure green crosshatch test pattern, to the point where the crosshatch test pattern again begins to show other colors. This is the **rear purity-adjustment limit** of the deflection yoke.
11. Position the deflection yoke to the middle of the forward and rear purity-adjustment limits. Rotate the deflection yoke until the green crosshatch test pattern is aligned with the physical CRT screen. Tighten the screw of the deflection yoke neck clamp.

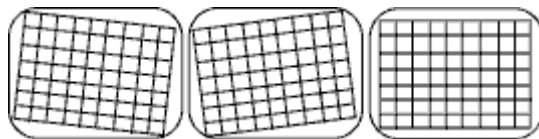

12. Carefully insert three temporary rubber wedges between the deflection yoke collar and the CRT glass neck to temporarily keep the deflection yoke straight and rigid.
13. Display a red crosshatch test pattern on the display. Check for good overall red purity.
14. Display a blue crosshatch test pattern on the display. Check for good overall blue purity.

Note for step 13 and 14: If the color is not uniform, re-adjustment of the purity magnet rings and/or slightly repositioning of the deflection yoke may be needed to obtain optimum purity for all colors. Go back and forth between adjustments and colors to find the "sweet spot" for purity magnet rings position and yoke position.

15. Perform the static convergence adjustments.

STATIC CONVERGENCE

If the horizontal centering adjustments have been performed, you must also perform both the static and dynamic convergence (in that order!)

1. Display a white crosshatch test pattern on the display.
2. Spread or close the angle of the 4-pole magnet rings with respect to each other (a virtual point between the two magnet ring tabs should always be stationary) to superimpose the red vertical lines with the blue vertical lines in the **center** of the display area. This will produce magenta vertical lines.

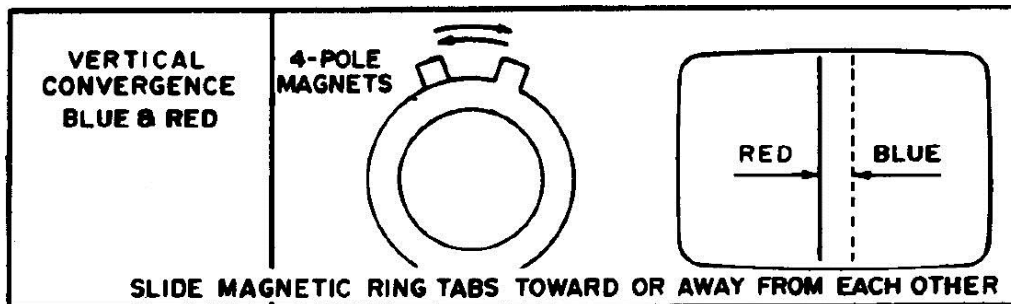

Do not attempt to adjust the convergence of the outer areas of the display at this time.

3. Keeping the angle between the 4-pole magnet rings the same, rotate both magnet rings together to superimpose the red horizontal lines with the blue horizontal lines in the **center** of the display area. This will produce magenta horizontal lines.

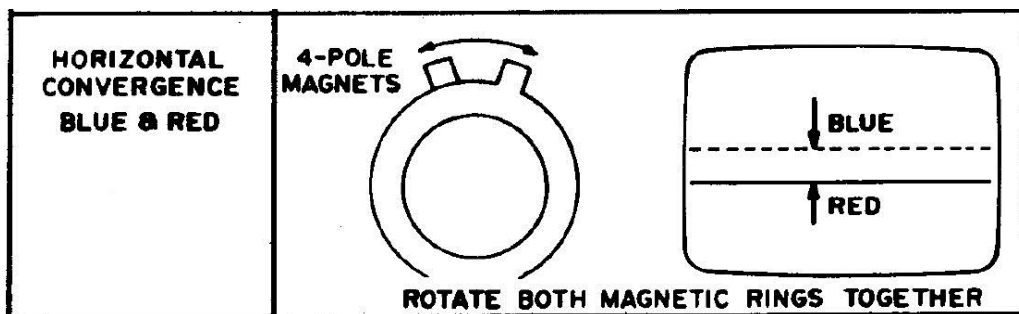

4. Spread or close the angle of the 6-pole magnet rings with respect to each other (a virtual point between the two magnet ring tabs should always be stationary) to superimpose the green vertical lines with the magenta vertical lines already converged in the **center** of the display area. This will produce white vertical lines.

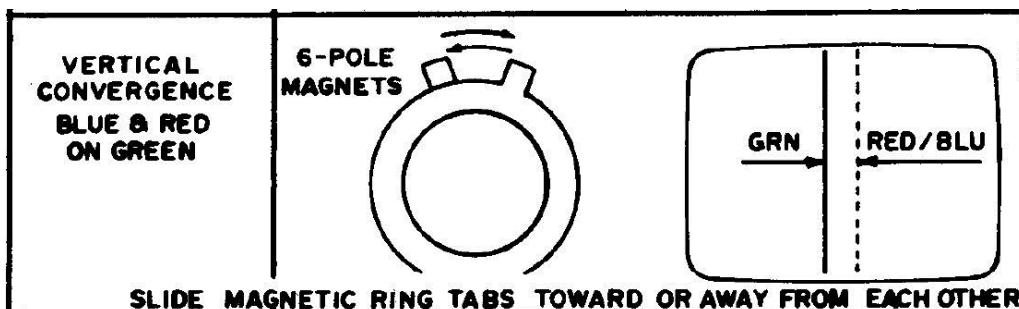

- Keeping the angle between the 6-pole magnet rings the same, rotate both magnet rings together to superimpose the green horizontal lines on the magenta horizontal lines already converged in the **center** of the display area. This will produce white horizontal lines.

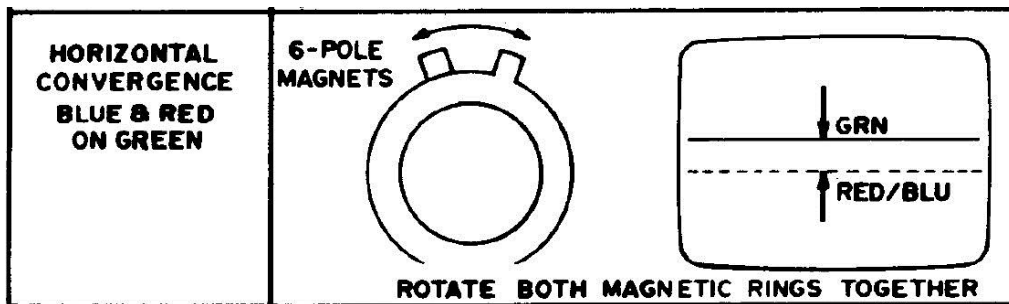

Note for step 2 to 5: As the 4-pole and 6-pole magnet rings affect each other it may be necessary to re-adjust them a second time. Go back and forth between the two static convergences to find the "sweet spot" for both 4-pole and 6-pole magnet rings positions together. In worst case it may be necessary to re-adjust the purity magnet rings and or deflection yoke position (as described in section Horizontal Centering (Purity))!

- Perform the dynamic convergence adjustments.

DYNAMIC CONVERGENCE

If the horizontal centering adjustments have been performed, you must also perform both the static and dynamic convergence (in that order!)

- Display a red and blue crosshatch test pattern on the display.
- Loosen the deflection yoke neck clamp slightly but not so much that the deflection yoke can move backward or forward or rotate.
- Remove the three temporary rubber wedges beneath the deflection yoke collar.
- Tilt the angle of the deflection yoke in a vertical direction (up/down) to adjust the **crossover convergence** in the **outer** display area of both vertical and horizontal red and blue lines so they superimpose each other to magenta.

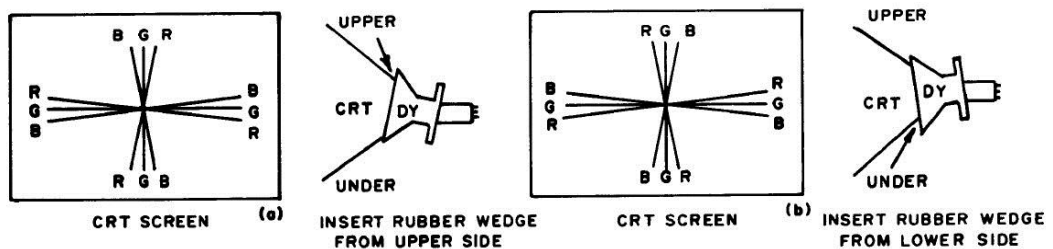

- While maintaining the vertical position (you can insert a temporary rubber wedge at the top) of the deflection yoke, tilt the angle of the deflection yoke in a horizontal direction (left/right) to adjust the parallel convergence in the outer display area of both vertical and horizontal red and blue lines so they superimpose each other to magenta.

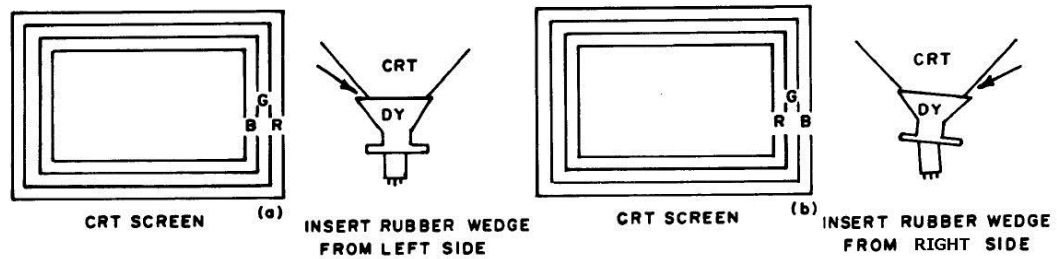

6. Carefully insert three rubber wedges beneath the deflection yoke collar (do **not** force them in. They are to be inserted until they just make contact with deflection yoke) spaced 120 degree apart to hold the deflection yoke in a fix position.

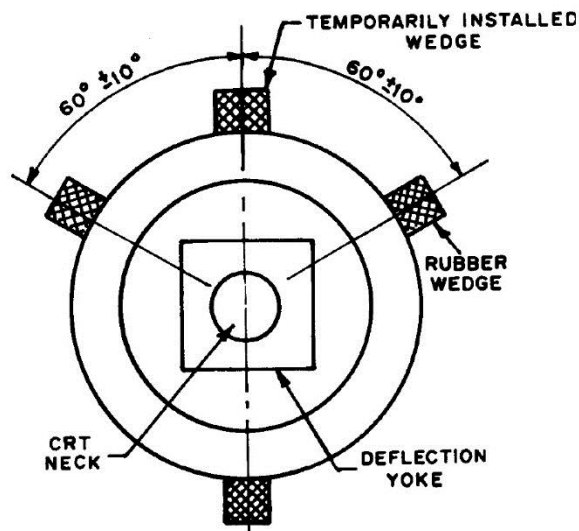

7. Display a white crosshatch test pattern on the display.
8. Check the display for good convergence at all areas of the display (this should appear as a pure white crosshatch test pattern). If necessary repeat static convergence and/or step 4 and 5 above.
9. Recheck the horizontal centering and make any necessary re-adjustments of the deflection yoke (as described in section *Horizontal Centering (Purity)*).
10. Tighten the deflection yoke neck clamp.
11. Fix the three rubber wedges to the CRT glass bell by gluing them with silicone rubber sealer or a hot glue gun.
12. After the glue has sealed enough to hold the wedges in place, carefully remove any temporarily installed rubber wedges.
13. Glue all magnetic rings on CCA with silicone rubber sealer or a hot glue gun

TRACKING

It is vital that horizontal centering adjustments have been performed prior to any tracking adjustments!

1. Apply power to the monitor and let it warm up for a minimum of 15 minutes.
2. Degauss the CRT with an external degaussing coil (see section *External Degaussing Coil*).
3. Set all BIAS controls and all DRIVE controls to their mid-position.

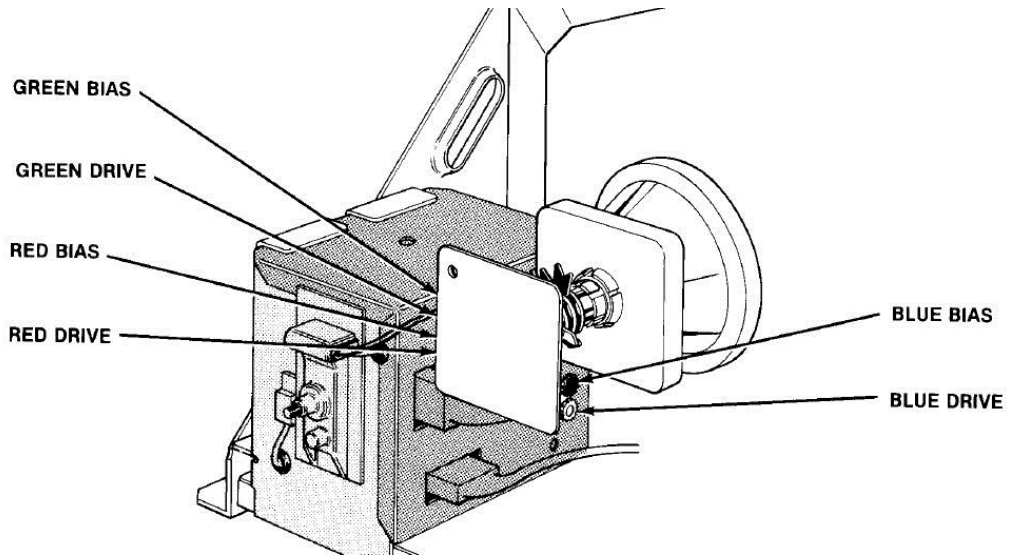

If the neck board is a P328 version turn the BRIGHTNESS control (R535) to a 2/3 CW rotation from the end CCW position.

4. Display a “color bar” test pattern on the display. This test pattern is part of a game’s self-test diagnostics.

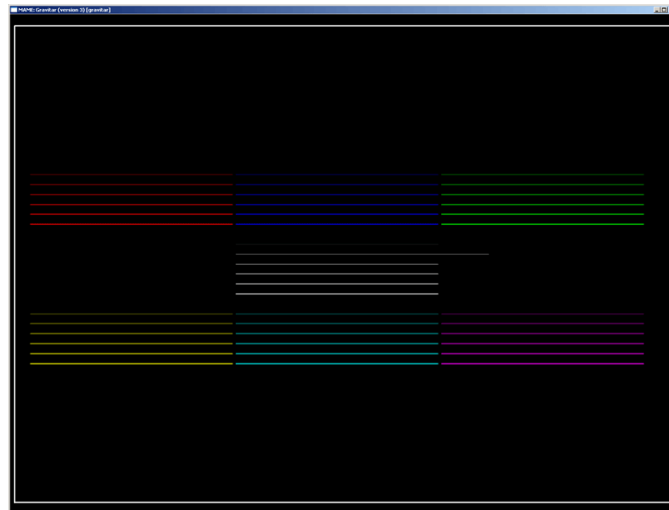

5. Set the MASTER SCREEN control so that the center group of lines barely just shows six lines.
6. Set the FOCUS control until you get the optimum picture sharpness possible.

7. Turn all BIAS controls and all DRIVE controls to their full clockwise position.
8. Turn the BRIGHTNESS control (or MASTER SCREEN control if the neck board is something else than P328) so that only five lines are visible in the center group of lines and the sixth line is completely invisible in the same group of lines.
9. Adjust the RED-BIAS (R516), GREEN-BIAS (R517) and BLUE-BIAS (R518) controls until the fifth line from the bottom in the center group of lines (the long white one) is pure white.
10. Adjust the RED-DRIVE (R507), GREEN-DRIVE (R508) and BLUE-DRIVE (R509) controls until the lowest line of the center group of lines is pure white.
11. If the fifth line from the bottom in the center group of lines (the long white one) is no longer pure white, repeat step 9 above.
12. Change the BRIGHTNESS (or MASTER SCREEN if the neck board is something else than P328) control back and forth to see if all lines in the center group of lines stay neutral gray. If any line becomes anything but grey - repeat step 9 and/or 10 as necessary.
13. Turn the BRIGHTNESS control (or MASTER SCREEN control if the neck board is something else than P328) so that only five lines are visible in the center group of lines and the sixth line is completely invisible in the same group of lines.

OPTIMIZING CONVERGENCE

1. Apply power to the monitor and let it warm up for a minimum of 15 minutes.
2. Degauss the CRT with an external degaussing coil (see section *External Degaussing Coil*).
3. Use the procedure described in section Optimizing Dynamic Convergence if necessary.

SETUP PROCEEDURE OF A 19" AMPLIFONE MONITOR

To be added.

SETUP PROCEEDURE OF A 19" WG K4900 MONITOR

To be added.